



# Lightning protection systems for gas pressure control and measurement systems

White Paper



## Contents

Risk analysis – Determination of the current state

Risk analysis of the gas pressure control and measurement system

Isolated external lightning protection system

Internal lightning protection –  
Lightning equipotential bonding –  
Surge protection

# Lightning protection systems for gas pressure control and measurement systems

## White Paper



The main functions of gas pressure control and measurement systems are to monitor and calculate gas volumes, automatically operate the stations by means of volume and condition-oriented connection and disconnection of measurement and control systems as well as volume control and monitoring of the gas transport between the distribution network operators.

Certain functional units that are connected to the power supply system are subject to the stipulations of section 3 of the German Ordinance on Industrial Safety and Health (BetrSichV). The operator must ensure compliance with these stipulations which apply to e.g. systems in potentially explosive atmospheres whose components are covered by the 94/9/EC directive, e.g. the installation of devices complying with the requirements of the 94/9/EC directive, their installation according to the state of the art, inspection and testing prior to commissioning and recurrent testing by a competent expert under the responsibility of the company.

The German Technical Rules on Operational Safety (TRBS) specify in greater detail the fundamental requirements of the German BetrSichV to be observed in this context. The German DVGW Code of Practice G 491 describes the requirements for electrical and non-electrical explosion protection of gas pressure control and measurement systems, referring to the existing TRBS as a source of information.

### Risk analysis – Determination of the current state

The current state of the system must be determined in a site survey. To this end, the structural conditions, existing documents and possible requirements of property insurers must be observed.

A risk analysis is performed in cooperation with the operator to define the protection measures required to prevent the destructive effects of lightning strikes and surges. To this end, designers use approved regulations that allow to design a complete protection concept.

The IEC 62305 (EN 62305) standard is a reliable design basis for future-oriented lightning protection systems. This standard is used to design, install, inspect and maintain lightning protection systems for structures.

The risk of a lightning strike and the necessity of a lightning protection system for an object to be protected are determined according to IEC 62305-1 (EN 62305-1) and IEC 62305-2 (EN 62305-2). Technically and economically optimal protection measures are selected depending on the risk. The IEC 62305-3 (EN 62305-3) and IEC 62305-4 (EN 62305-4) standards describe how to implement the protection measures determined. Thus, the IEC 62305 (EN 62305) standard is a solid basis for operators and designers. This standard makes it easier to take further protection measures for wide-

spread power supply and information technology systems at lower costs. The IEC 62305-4 (EN 62305-4) standard describes measures for protecting electronic systems.

### Risk analysis of the gas pressure control and measurement system

The protection of the structure and technical equipment against the effects of a lightning strike and personal protection must be taken into account right from the design stage. For this reason, adequate protection goals are defined together with the operator before performing a risk analysis.

In our example, the protection goals would be:

- ➔ Fire and explosion protection
- ➔ Personal protection
- ➔ Protection of the electronics of systems with high availability

At first, the loss factors according to IEC 62305 (EN 62305), the required availability and the risk are determined. This leads to the following loss factors:

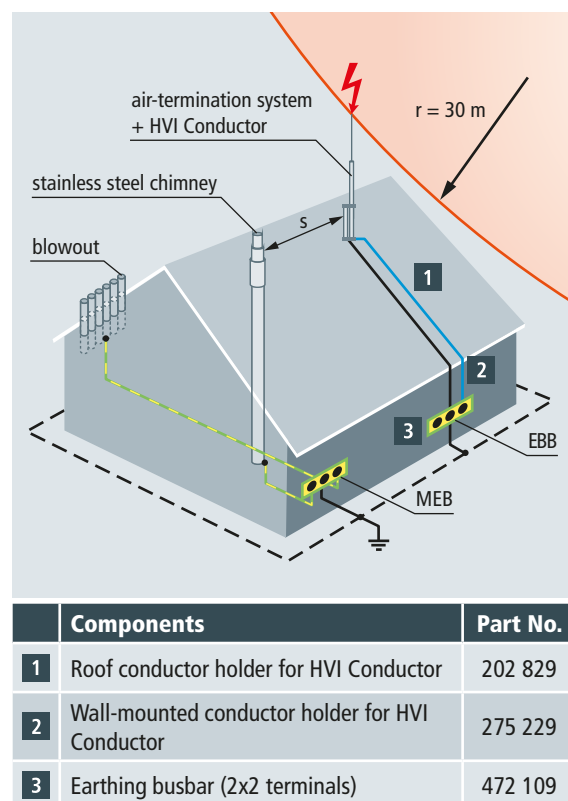
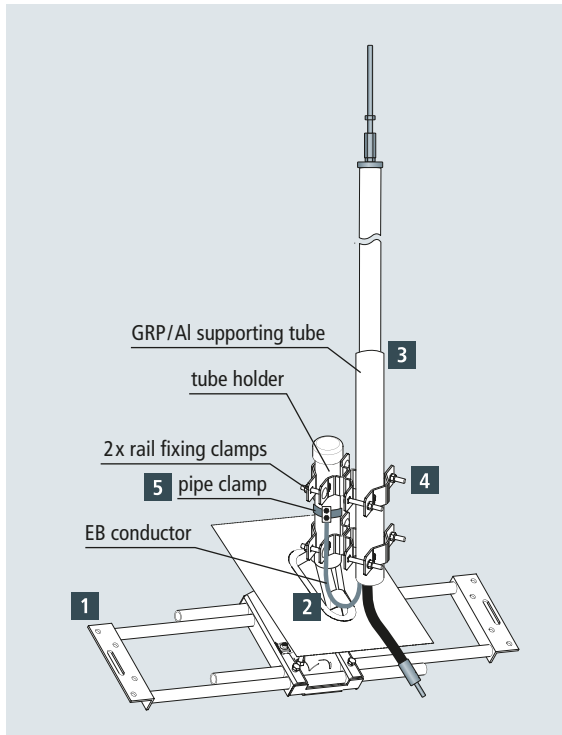

Figure 1 Isolated external lightning protection system for a gable roof

# Lightning protection systems for gas pressure control and measurement systems

## White Paper



	Components	Part No.
1	Rafter holder	105 240
2	Roof bushing kit	105 245
3	DEHNcon-H HVI Conductor I integrated in the supporting tube with air-termination rod	819 245
4	Rail fixing clamp	105 354
5	Antenna pipe clamp	540 103

Figure 2 Isolated external lightning protection system for a gable roof – Installation option 1

- ➔ L1: Injury or death of persons (loss factor L1 includes the lightning-related ignition source specified in TRBS 2152 Part 3 with regard to explosion protection)
- ➔ L2: Loss of service to the public
- ➔ L4: Loss of economic value

The example described below was calculated based on IEC 62305-2 (EN 62305-2) by means of the DEHNsupport software. We expressly point out that the procedure shown is only an example. The solution in **Figure 1** is not binding in any way and can be substituted by other equiva-

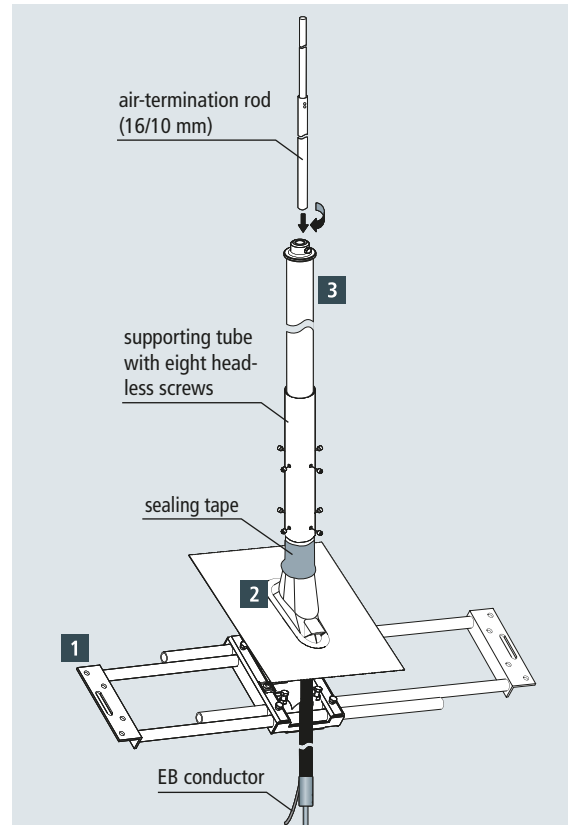

	Components	Part No.
1	Rafter holder	105 240
2	Roof bushing kit	105 245
3	DEHNcon-H HVI Conductor I integrated in the supporting tube with air-termination rod	819 245

Figure 3 Isolated external lightning protection system for a gable roof – Installation option 2

lent solutions. In the following, possible protection solutions based on LPL II and the most important characteristics of the example depending on the type of installation are described. A high-voltage-resistant, insulated down conductor (HVI Conductor I) can be installed on (**Figure 2**) or underneath (**Figure 3**) the roofing.

If conductors must be installed in Ex zone 1 or 2 due to local conditions, installation instructions No. 1501 must be observed. **Figures 4 and 5** show an example of a flat-roofed gas pressure control and measurement system.

# Lightning protection systems for gas pressure control and measurement systems

## White Paper

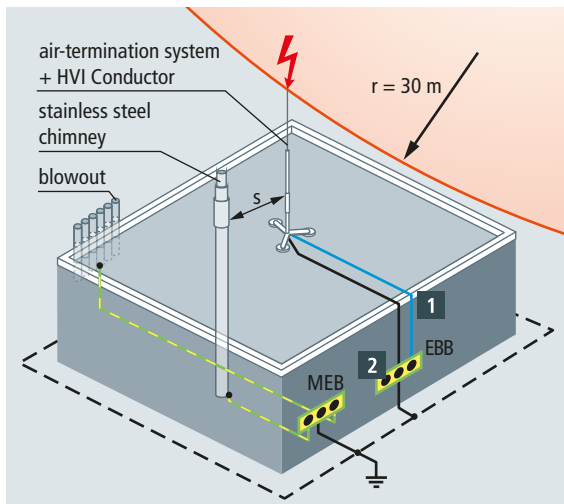

	Components	Part No.
	HVI Ex W70 holder	275 440
1	HVI Ex W200 holder	275 441
	HVI Ex busbar 500	275 498
2	Earthing busbar (2x2 terminals)	472 109

Figure 4 Isolated external lightning protection system for a flat roof

### Internal lightning protection – Lightning equipotential bonding – Surge protection

All conductive systems entering the gas pressure control and measurement system from the outside must be integrated in the lightning equipotential bonding system (Figure 6). This is achieved by directly connecting all metal systems and indirectly connecting all live systems via surge protective devices. These surge protective devices must be capable of discharging lightning currents (type 1 SPD: test wave form 10/350  $\mu$ s). Lightning equipotential bonding should be established as close as possible to the entry point into the structure (zone transition from LPZ 0 to 1 or higher) to reduce high potential differences and dangerous sparkover in potentially explosive atmospheres and to prevent partial lightning currents from entering the structure.

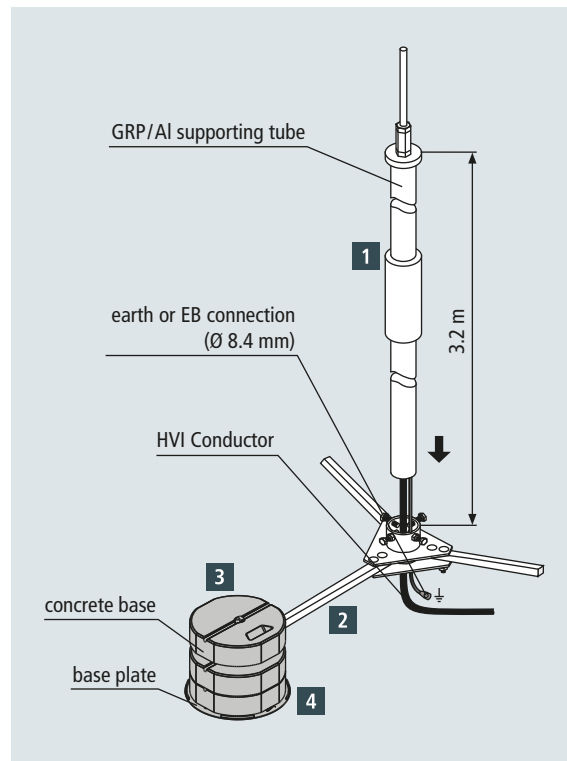

	Components	Part No.
1	Supporting tube with HVI Conductor	819 320
2	Tripod for supporting tubes	105 350
3	Concrete base	102 010
4	Base plate	102 050

Figure 5 Isolated external lightning protection system for a flat roof - Installation option 3

Additional protection measures as per IEC 62305-4 (EN 62305-4) for increasing the availability of sensitive electrical systems may be required depending on the immunity level and installation environment of the systems. A combination of surge protection, shielding and supplementary equipotential bonding measures have proven their worth in practice.

# Lightning protection systems for gas pressure control and measurement systems

## White Paper

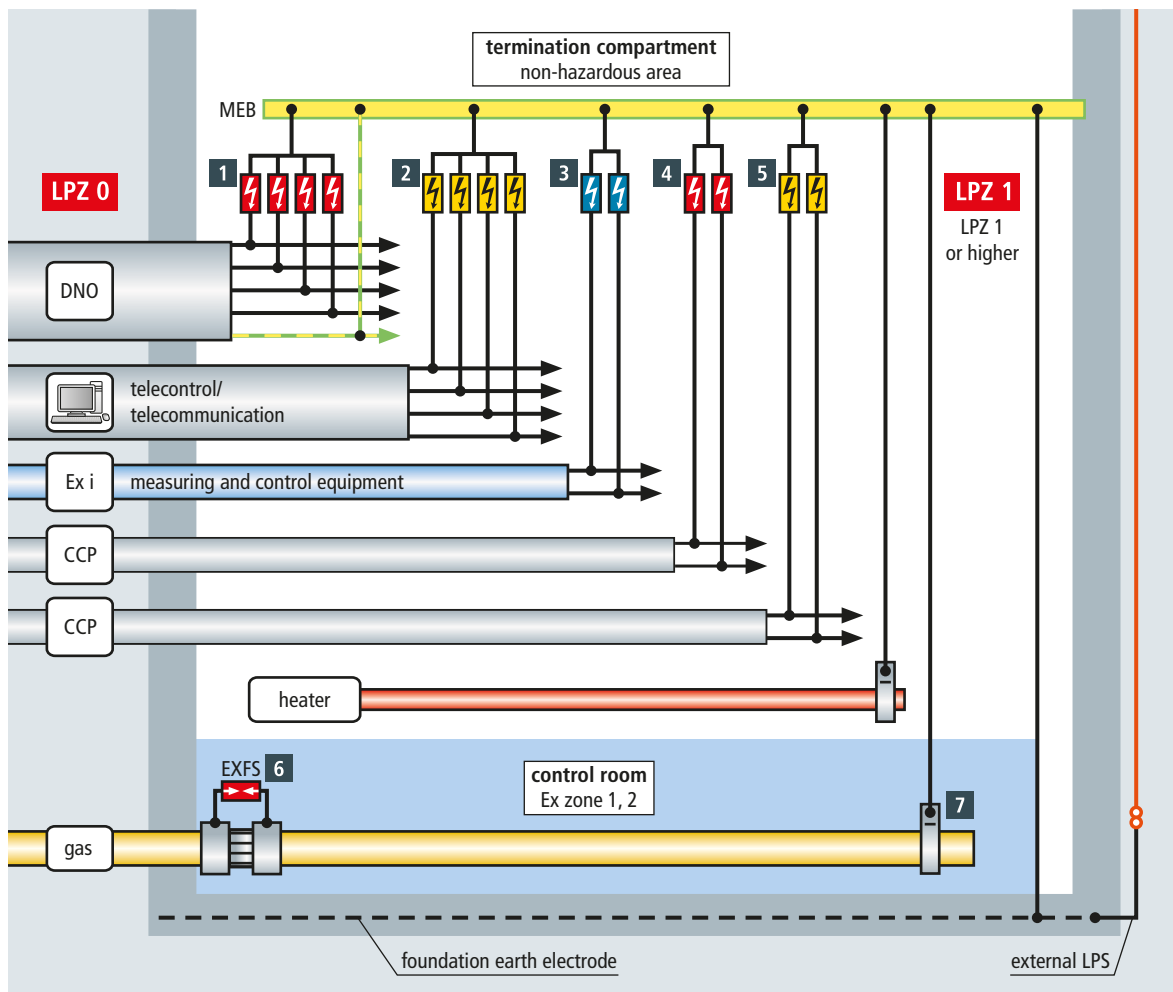

Figure 6 Lightning equipotential bonding for incoming lines

# Lightning protection systems for gas pressure control and measurement systems

## White Paper



No. in Figure 6	Protection for	Surge protective device	Part No.
<b>Power supply systems</b>			
1	Three-phase TN-S/TT system	DEHNventil M TT 255 FM	951 315
	Three-phase TN-C system	DEHNventil M TNC 255 FM	951 305
	Alternating current TN system	DEHNventil M TN 255 FM	951 205
	Alternating current TT system	DEHNventil M TT 2P 255 FM	951 115
<b>Information technology systems</b>			
2	Telecontrol, telecommunication systems	BXT ML4 BD 180 or BXT ML2 BD 180 + BXT BAS	920 347 920 247 + 920 300
<b>Measuring and control equipment</b>			
3	Intrinsically safe measuring circuits and systems	BXT ML4 BD EX 24 or BXT ML2 BD S EX 24 + BXT BAS EX	920 381 920 280 + 920 301
<b>Cathodic protection systems</b>			
4	Cathodic protection system, protective circuit up to 12 A	BVT KKS ALD 75	918 420
	Cathodic protection system, protective circuit exceeding 12 A	DEHNbloc M 1 150 FM + DEHNguard S 150 FM + MVS 1 2	961 115 + 952 092 + 900 617
5	Cathodic protection system, sensor measuring circuit	BVT KKS APD 36	918 421
<b>Functionally isolated systems parts</b>			
6	Insulating joints / insulating flanges	EXFS 100 or EXFS 100 KU	923 100 923 101
<b>Equipotential bonding in hazardous areas</b>			
7	Connection of pipelines without ignition sparks	EX BRS 27 or EX BRS 90 or EX BRS 300 or EX BRS 500	540 821 540 801 540 803 540 805

Table 1 Recommended lightning equipotential bonding components according to Figure 9.33.6

## DEHNventil

### DV M TT 2P 255 FM (951 115)

- Prewired spark-gap-based type 1 and type 2 combined lightning current and surge arrester consisting of a base part and plug-in protection modules
- Maximum system availability due to RADAX Flow follow current limitation
- Capable of protecting terminal equipment



Figure without obligation

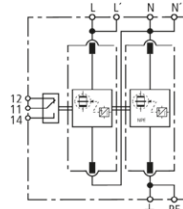

Basic circuit diagram DV M TT 2P 255 FM

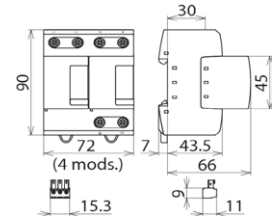

Dimension drawing DV M TT 2P 255 FM

Modular combined lightning current and surge arrester for single-phase TT and TN systems ("1+1" circuit).

Type Part No.	DV M TT 2P 255 FM 951 115
SPD according to EN 61643-11 / IEC 61643-11	type 1 + type 2 / class I + class II
Energy coordination with terminal equipment ( $\leq 5$ m)	type 1 + type 2 + type 3
Nominal a.c. voltage ( $U_n$ )	230 V (50 / 60 Hz)
Max. continuous operating a.c. voltage [L-N] ( $U_c$ )	264 V (50 / 60 Hz)
Max. continuous operating a.c. voltage [N-PE] ( $U_{c(N-PE)}$ )	255 V (50 / 60 Hz)
Lightning impulse current (10/350 $\mu$ s) [L+N-PE] ( $I_{total}$ )	50 kA
Specific energy [L+N-PE] (W/R)	625.00 kJ/ohms
Lightning impulse current (10/350 $\mu$ s) [L-N]/[N-PE] ( $I_{imp}$ )	25 / 50 kA
Specific energy [L-N]/[N-PE] (W/R)	156.25 / 625.00 kJ/ohms
Nominal discharge current (8/20 $\mu$ s) [L-N]/[N-PE] ( $I_n$ )	25 / 50 kA
Voltage protection level [L-N]/[N-PE] ( $U_p$ )	$\leq 1.5$ / $\leq 1.5$ kV
Follow current extinguishing capability [L-N]/[N-PE] ( $I_n$ )	50 kA <sub>rms</sub> / 100 A <sub>rms</sub>
Follow current limitation / Selectivity	no tripping of a 20 A gL/gG fuse up to 50 kA <sub>rms</sub> (prosp.)
Response time ( $t_A$ )	$\leq 100$ ns
Max. backup fuse (L) up to $I_k = 50$ kA <sub>rms</sub>	315 A gG
Max. backup fuse (L-L')	125 A gG
Temporary overvoltage (TOV) [L-N] ( $U_T$ ) – Characteristic	440 V / 120 min. – withstand
Temporary overvoltage (TOV) [N-PE] ( $U_T$ ) – Characteristic	1200 V / 200 ms – withstand
Operating temperature range [parallel] / [series] ( $T_U$ )	-40 °C ... +80 °C / -40 °C ... +60 °C
Operating state / fault indication	green / red
Number of ports	1
Cross-sectional area (L, L', N, N', PE, $\ominus$ ) (min.)	10 mm <sup>2</sup> solid / flexible
Cross-sectional area (L, N, PE) (max.)	50 mm <sup>2</sup> stranded / 35 mm <sup>2</sup> flexible
Cross-sectional area (L', N', $\ominus$ ) (max.)	35 mm <sup>2</sup> stranded / 25 mm <sup>2</sup> flexible
For mounting on	35 mm DIN rails acc. to EN 60715
Enclosure material	thermoplastic, red, UL 94-V-0
Place of installation	indoor installation
Degree of protection	IP 20
Capacity	4 module(s), DIN 43880
Approvals	KEMA, VDE, UL, VdS
Type of remote signalling contact	changeover contact
a.c. switching capacity	250 V / 0.5 A
d.c. switching capacity	250 V / 0.1 A; 125 V / 0.2 A; 75 V / 0.5 A
Cross-sectional area for remote signalling terminals	max. 1.5 mm <sup>2</sup> solid / flexible
Extended technical data:	Use in switchgear installations with prospective short-circuit currents of more than 50 kA <sub>rms</sub> (tested by the German VDE)
– Max. prospective short-circuit current	100 kA <sub>rms</sub> (220 kA <sub>peak</sub> )
– Limitation / Exinction of mains follow currents	up to 100 kA <sub>rms</sub> (220 kA <sub>peak</sub> )
– Max. backup fuse (L) up to $I_k = 100$ kA <sub>rms</sub>	315 A gL/gG
Weight	664 g
Customs tariff number	85363030
GTIN	4013364108127
PU	1 pc(s)

## DEHNventil

### DV M TN 255 FM (951 205)

- Prewired spark-gap-based type 1 and type 2 combined lightning current and surge arrester consisting of a base part and plug-in protection modules
- Maximum system availability due to RADAX Flow follow current limitation
- Capable of protecting terminal equipment



Figure without obligation

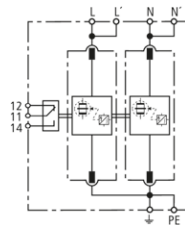

Basic circuit diagram DV M TN 255 FM

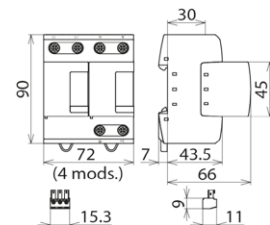

Dimension drawing DV M TN 255 FM

Modular combined lightning current and surge arrester for single-phase TN systems.

Type Part No.	DV M TN 255 FM 951 205
SPD according to EN 61643-11 / IEC 61643-11	type 1 + type 2 / class I + class II
Energy coordination with terminal equipment ( $\leq 5$ m)	type 1 + type 2 + type 3
Nominal a.c. voltage ( $U_N$ )	230 V (50 / 60 Hz)
Max. continuous operating a.c. voltage ( $U_C$ )	264 V (50 / 60 Hz)
Lightning impulse current (10/350 $\mu$ s) [L+N-PE] ( $I_{total}$ )	50 kA
Specific energy [L+N-PE] (W/R)	625.00 kJ/ohms
Lightning impulse current (10/350 $\mu$ s) [L, N-PE] ( $I_{imp}$ )	25 kA
Specific energy [L,N-PE] (W/R)	156.25 kJ/ohms
Nominal discharge current (8/20 $\mu$ s) [L/N-PE]/[L+N-PE] ( $I_n$ )	25 / 50 kA
Voltage protection level [L-PE]/[N-PE] ( $U_P$ )	$\leq 1.5$ / $\leq 1.5$ kV
Follow current extinguishing capability a.c. ( $I_n$ )	50 kA <sub>rms</sub>
Follow current limitation / Selectivity	no tripping of a 20 A gL/gG fuse up to 50 kA <sub>rms</sub> (prosp.)
Response time ( $t_A$ )	$\leq 100$ ns
Max. backup fuse (L) up to $I_k = 50$ kA <sub>rms</sub>	315 A gG
Max. backup fuse (L-L')	125 A gG
Temporary overvoltage (TOV) [L-N] ( $U_T$ ) – Characteristic	440 V / 120 min. – withstand
Operating temperature range [parallel] / [series] ( $T_U$ )	-40 °C ... +80 °C / -40 °C ... +60 °C
Operating state / fault indication	green / red
Number of ports	1
Cross-sectional area (L, L', N, N', PE, $\pm$ ) (min.)	10 mm <sup>2</sup> solid / flexible
Cross-sectional area (L, N, PE) (max.)	50 mm <sup>2</sup> stranded / 35 mm <sup>2</sup> flexible
Cross-sectional area (L', N', $\pm$ ) (max.)	35 mm <sup>2</sup> stranded / 25 mm <sup>2</sup> flexible
For mounting on	35 mm DIN rails acc. to EN 60715
Enclosure material	thermoplastic, red, UL 94 V-0
Place of installation	indoor installation
Degree of protection	IP 20
Capacity	4 module(s), DIN 43880
Approvals	KEMA, VDE, UL, VdS
Type of remote signalling contact	changeover contact
a.c. switching capacity	250 V / 0.5 A
d.c. switching capacity	250 V / 0.1 A; 125 V / 0.2 A; 75 V / 0.5 A
Cross-sectional area for remote signalling terminals	max. 1.5 mm <sup>2</sup> solid / flexible
Extended technical data:	Use in switchgear installations with prospective short-circuit currents of more than 50 kA <sub>rms</sub> (tested by the German VDE)
– Max. prospective short-circuit current	100 kA <sub>rms</sub> (220 kA <sub>peak</sub> )
– Limitation / Extinction of mains follow currents	up to 100 kA <sub>rms</sub> (220 kA <sub>peak</sub> )
– Max. backup fuse (L) up to $I_k = 100$ kA <sub>rms</sub>	315 A gL/gG
Weight	668 g
Customs tariff number	85363030
GTIN	4013364108103
PU	1 pc(s)



## DEHNventil

### DV M TNC 255 FM (951 305)

- Prewired combined type 1 and type 2 spark-gap-based lightning current and surge arrester consisting of a base part and plug-in protection modules
- Maximum system availability due to RADAX Flow follow current limitation
- Capable of protecting terminal equipment



Figure without obligation

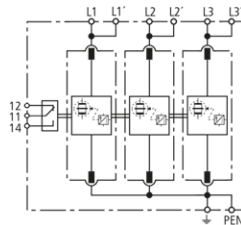

Basic circuit diagram DV M TNC 255 FM

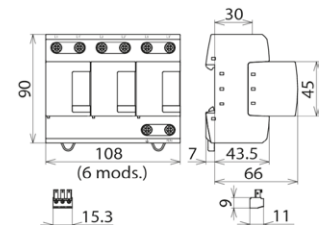

Dimension drawing DV M TNC 255 FM

Modular combined lightning current and surge arrester for TN-C systems.

Type Part No.	DV M TNC 255 FM 951 305
SPD according to EN 61643-11 / IEC 61643-11	type 1 + type 2 / class I + class II
Energy coordination with terminal equipment ( $\leq 5$ m)	type 1 + type 2 + type 3
Nominal a.c. voltage ( $U_N$ )	230 / 400 V (50 / 60 Hz)
Max. continuous operating a.c. voltage ( $U_C$ )	264 V (50 / 60 Hz)
Lightning impulse current (10/350 $\mu$ s) [L1+L2+L3-PEN] ( $I_{total}$ )	75 kA
Specific energy [L1+L2+L3-PEN] (W/R)	1.40 MJ/ohms
Lightning impulse current (10/350 $\mu$ s) [L-PEN] ( $I_{imp}$ )	25 kA
Specific energy [L-PEN] (W/R)	156.25 kJ/ohms
Nominal discharge current (8/20 $\mu$ s) [L-PEN]/[L1+L2+L3-PEN] ( $I_n$ )	25 / 75 kA
Voltage protection level ( $U_p$ )	$\leq 1.5$ kV
Follow current extinguishing capability a.c. ( $I_n$ )	50 kA <sub>rms</sub>
Follow current limitation / Selectivity	no tripping of a 20 A gL/gG fuse up to 50 kA <sub>rms</sub> (prosp.)
Response time ( $t_A$ )	$\leq 100$ ns
Max. backup fuse (L) up to $I_k = 50$ kA <sub>rms</sub>	315 A gG
Max. backup fuse (L-L')	125 A gG
Temporary overvoltage (TOV) ( $U_T$ ) – Characteristic	440 V / 120 min. – withstand
Operating temperature range [parallel] / [series] ( $T_U$ )	-40 °C ... +80 °C / -40 °C ... +60 °C
Operating state / fault indication	green / red
Number of ports	1
Cross-sectional area (L1, L1', L2, L2', L3, L3', PEN, $\pm$ ) (min.)	10 mm <sup>2</sup> solid / flexible
Cross-sectional area (L1, L2, L3, PEN) (max.)	50 mm <sup>2</sup> stranded / 35 mm <sup>2</sup> flexible
Cross-sectional area (L1', L2', L3', $\pm$ ) (max.)	35 mm <sup>2</sup> stranded / 25 mm <sup>2</sup> flexible
For mounting on	35 mm DIN rails acc. to EN 60715
Enclosure material	thermoplastic, red, UL 94 V-0
Place of installation	indoor installation
Degree of protection	IP 20
Capacity	6 module(s), DIN 43880
Approvals	KEMA, VDE, UL, VdS
Type of remote signalling contact	changeover contact
a.c. switching capacity	250 V / 0.5 A
d.c. switching capacity	250 V / 0.1 A; 125 V / 0.2 A; 75 V / 0.5 A
Cross-sectional area for remote signalling terminals	max. 1.5 mm <sup>2</sup> solid / flexible
Extended technical data:	Use in switchgear installations with prospective short-circuit currents of more than 50 kA <sub>rms</sub> (tested by the German VDE)
– Max. prospective short-circuit current	100 kA <sub>rms</sub> (220 kA <sub>peak</sub> )
– Limitation / Extinction of mains follow currents	up to 100 kA <sub>rms</sub> (220 kA <sub>peak</sub> )
– Max. backup fuse (L) up to $I_k = 100$ kA <sub>rms</sub>	315 A gL/gG
Weight	962 g
Customs tariff number	85363030
GTIN	4013364108141
PU	1 pc(s)

## DEHNventil

### DV M TT 255 FM (951 315)

- Prewired spark-gap-based type 1 and type 2 combined lightning current and surge arrester consisting of a base part and plug-in protection modules
- Maximum system availability due to RADAX Flow follow current limitation
- Capable of protecting terminal equipment



Figure without obligation

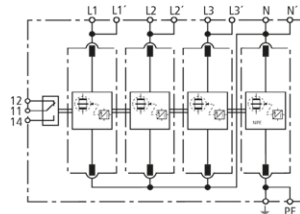

Basic circuit diagram DV M TT 255 FM

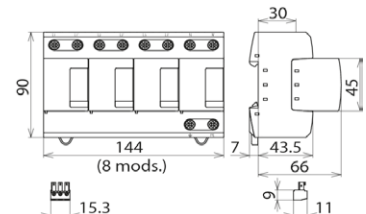

Dimension drawing DV M TT 255 FM

Modular combined lightning current and surge arrester for TT and TN-S systems ("3+1" circuit).

Type	DV M TT 255 FM
Part No.	951 315
SPD according to EN 61643-11 / IEC 61643-11	type 1 + type 2 / class I + class II
Energy coordination with terminal equipment ( $\leq 5$ m)	type 1 + type 2 + type 3
Nominal a.c. voltage ( $U_n$ )	230 / 400 V (50 / 60 Hz)
Max. continuous operating a.c. voltage [L-N] ( $U_c$ )	264 V (50 / 60 Hz)
Max. continuous operating a.c. voltage [N-PE] ( $U_{c(N-PE)}$ )	255 V (50 / 60 Hz)
Lightning impulse current (10/350 $\mu$ s) [L1+L2+L3+N-PE] ( $I_{total}$ )	100 kA
Specific energy [L1+L2+L3+N-PE] (W/R)	2.50 MJ/ohms
Lightning impulse current (10/350 $\mu$ s) [L-N]/[N-PE] ( $I_{imp}$ )	25 / 100 kA
Specific energy [L-N]/[N-PE] (W/R)	156.25 kJ/ohms / 2.50 MJ/ohms
Nominal discharge current (8/20 $\mu$ s) [L-N]/[N-PE] ( $I_n$ )	25 / 100 kA
Voltage protection level [L-N]/[N-PE] ( $U_p$ )	$\leq 1.5$ / $\leq 1.5$ kV
Follow current extinguishing capability [L-N]/[N-PE] ( $I_n$ )	50 kA <sub>rms</sub> / 100 A <sub>rms</sub>
Follow current limitation / Selectivity	no tripping of a 20 A gL/gG fuse up to 50 kA <sub>rms</sub> (prosp.)
Response time ( $t_A$ )	$\leq 100$ ns
Max. backup fuse (L) up to $I_k = 50$ kA <sub>rms</sub>	315 A gG
Max. backup fuse (L-L')	125 A gG
Temporary overvoltage (TOV) [L-N] ( $U_T$ ) – Characteristic	440 V / 120 min. – withstand
Temporary overvoltage (TOV) [N-PE] ( $U_T$ ) – Characteristic	1200 V / 200 ms – withstand
Operating temperature range [parallel] / [series] ( $T_U$ )	-40 °C ... +80 °C / -40 °C ... +60 °C
Operating state / fault indication	green / red
Number of ports	1
Cross-sectional area (L1, L1', L2, L2', L3, L3', N, N', PE, $\pm$ ) (min.)	10 mm <sup>2</sup> solid / flexible
Cross-sectional area (L1, L2, L3, N, PE) (max.)	50 mm <sup>2</sup> stranded / 35 mm <sup>2</sup> flexible
Cross-sectional area (L1', L2', L3', N', $\pm$ ) (max.)	35 mm <sup>2</sup> stranded / 25 mm <sup>2</sup> flexible
For mounting on	35 mm DIN rails acc. to EN 60715
Enclosure material	thermoplastic, red, UL 94 V-0
Place of installation	indoor installation
Degree of protection	IP 20
Capacity	8 module(s), DIN 43880
Approvals	KEMA, VDE, UL, VdS
Type of remote signalling contact	changeover contact
a.c. switching capacity	250 V / 0.5 A
d.c. switching capacity	250 V / 0.1 A; 125 V / 0.2 A; 75 V / 0.5 A
Cross-sectional area for remote signalling terminals	max. 1.5 mm <sup>2</sup> solid / flexible
Extended technical data:	Use in switchgear installations with prospective short-circuit currents of more than 50 kA <sub>rms</sub> (tested by the German VDE)
– Max. prospective short-circuit current	100 kA <sub>rms</sub> (220 kA <sub>peak</sub> )
– Limitation / Extinction of mains follow currents	up to 100 kA <sub>rms</sub> (220 kA <sub>peak</sub> )
– Max. backup fuse (L) up to $I_k = 100$ kA <sub>rms</sub>	315 A gL/gG
Weight	1,28 kg
Customs tariff number	85363030
GTIN	4013364108189
PU	1 pc(s)

## DEHNbloc

### DB M 1 150 FM (961 115)

- Coordinated spark-gap-based lightning current arrester consisting of a base part and plug-in protection module
- Maximum system availability due to RADAX Flow follow current limitation
- Without additional cable length directly coordinated with DEHNguard surge protective device



Figure without obligation

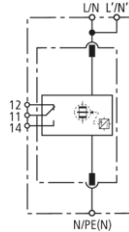

Basic circuit diagram DB M 1 150 FM

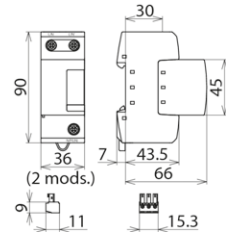

Dimension drawing DB M 1 150 FM

Coordinated modular single-pole lightning current arrester with high follow current limitation; with remote signalling contact for the monitoring system (floating changeover contact)

Type Part No.	DB M 1 150 FM 961 115
SPD according to EN 61643-11	Type 1
SPD according to IEC 61643-1/-11	Class I
Max. continuous operating a.c. voltage ( $U_c$ )	150 V
Lightning impulse current (10/350 $\mu$ s) ( $I_{imp}$ )	35 kA
Specific energy (W/R)	306.25 kJ/ohms
Nominal discharge current (8/20 $\mu$ s) ( $I_n$ )	35 kA
Voltage protection level ( $U_p$ )	$\leq 1.5$ kV
Follow current extinguishing capability a.c. ( $I_{fi}$ )	50 kA <sub>rms</sub>
Follow current limitation/Selectivity	no tripping of a 32 A gL/gG fuse up to 50 kA <sub>rms</sub> (prosp.)
Response time ( $t_A$ )	$\leq 100$ ns
Max. backup fuse (L) up to $I_k = 50$ kA <sub>rms</sub> ( $t_d \leq 0.2$ s)	500 A gL/gG
Max. backup fuse (L) up to $I_k = 50$ kA <sub>rms</sub> ( $t_d \leq 5$ s)	315 A gL/gG
Max. backup fuse (L) for $I_k > 50$ kA <sub>rms</sub>	200 A gL/gG
Max. backup fuse (L-L')	125 A gL/gG
Temporary overvoltage (TOV) ( $U_T$ )	200 V / 5 sec.
TOV characteristic	withstand
Operating temperature range (parallel connection) ( $T_{UP}$ )	-40°C...+80°C
Operating temperature range (series connection) ( $T_{US}$ )	-40°C...+60°C
Operating state/fault indication	green / red
Number of ports	1
Cross-sectional area (L/N, L'/N', N/PE (N)) (min.)	10 mm <sup>2</sup> solid/flexible
Cross-sectional area (L/N, N/PE(N)) (max.)	50 mm <sup>2</sup> stranded/35 mm <sup>2</sup> flexible
Cross-sectional area (L'/N') (max.)	35 mm <sup>2</sup> stranded/25 mm <sup>2</sup> flexible
For mounting on	35 mm DIN rails acc. to EN 60715
Enclosure material	thermoplastic, red, UL 94 V-0
Place of installation	indoor installation
Degree of protection	IP 20
Capacity	2 module(s), DIN 43880
Approvals	VDE, UL, CSA
Type of remote signalling contact	changeover contact
a.c. switching capacity	250 V/0.5 A
d.c. switching capacity	250 V/0.1 A; 125 V/0.2 A; 75 V/0.5 A
Cross-sectional area for remote signalling terminals	max. 1.5 mm <sup>2</sup> solid/flexible
Weight	321 g
Customs tariff number	85363030
GTIN	4013364118577
PU	1 pc(s)

## DEHNguard S

### DG S 150 (952 072)

- Multi-purpose surge arrester consisting of a base element and plug-in protection module
- High discharge capacity due to heavy-duty zinc oxide varistor
- High reliability due to "Thermo Dynamic Control" SPD monitoring device



Figure without obligation

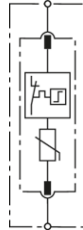

Basic circuit diagram DG S 150

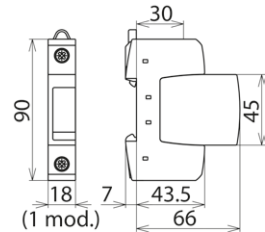

Dimension drawing DG S 150

Pluggable single-pole surge arrester consisting of a base part and plug-in protection module.

Type	DG S 150
Part No.	952 072
SPD according to EN 61643-11 / IEC 61643-11	type 2 / class II
Nominal a.c. voltage ( $U_N$ )	120 V (50 / 60 Hz)
Max. continuous operating a.c. voltage ( $U_C$ )	150V (50 / 60 Hz)
Max. continuous operating d.c. voltage ( $U_C$ )	200 V
Nominal discharge current (8/20 $\mu$ s) ( $I_n$ )	15 kA
Max. discharge current (8/20 $\mu$ s) ( $I_{max}$ )	40 kA
Voltage protection level ( $U_p$ )	$\leq 0.7$ kV
Voltage protection level at 5 kA ( $U_p$ )	$\leq 0.55$ kV
Response time ( $t_A$ )	$\leq 25$ ns
Max. mains-side overcurrent protection	125 A gG
Short-circuit withstand capability for max. mains-side overcurrent protection ( $I_{SCCR}$ )	50 kA <sub>rms</sub>
Temporary overvoltage (TOV) ( $U_T$ ) – Characteristic	175 V / 5 sec. – withstand
Temporary overvoltage (TOV) ( $U_T$ ) – Characteristic	230 V / 120 min. – safe failure
Operating temperature range ( $T_U$ )	-40 °C ... +80 °C
Operating state / fault indication	green / red
Number of ports	1
Cross-sectional area (min.)	1.5 mm <sup>2</sup> solid / flexible
Cross-sectional area (max.)	35 mm <sup>2</sup> stranded / 25 mm <sup>2</sup> flexible
For mounting on	35 mm DIN rails acc. to EN 60715
Enclosure material	thermoplastic, red, UL 94 V-0
Place of installation	indoor installation
Degree of protection	IP 20
Capacity	1 module(s), DIN 43880
Approvals	KEMA, VDE, UL, VdS, CSA
Weight	109 g
Customs tariff number	85363030
GTIN	4013364109858
PU	1 pc(s)

## DEHNguard S

### DG S 150 FM (952 092)

- Multi-purpose surge arrester consisting of a base element and plug-in protection module
- High discharge capacity due to heavy-duty zinc oxide varistor
- High reliability due to "Thermo Dynamic Control" SPD monitoring device



Figure without obligation

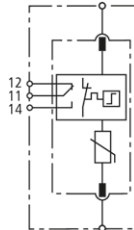

Basic circuit diagram DG S 150 FM

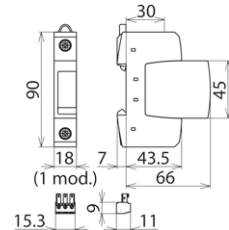

Dimension drawing DG S 150 FM

Pluggable single-pole surge arrester consisting of a base part and plug-in protection module; with floating remote signalling contact.

Type	DG S 150 FM
Part No.	952 092
SPD according to EN 61643-11 / IEC 61643-11	type 2 / class II
Nominal a.c. voltage ( $U_N$ )	120 V (50 / 60 Hz)
Max. continuous operating a.c. voltage ( $U_C$ )	150V (50 / 60 Hz)
Max. continuous operating d.c. voltage ( $U_C$ )	200 V
Nominal discharge current (8/20 $\mu$ s) ( $I_n$ )	15 kA
Max. discharge current (8/20 $\mu$ s) ( $I_{max}$ )	40 kA
Voltage protection level ( $U_P$ )	$\leq 0.7$ kV
Voltage protection level at 5 kA ( $U_P$ )	$\leq 0.55$ kV
Response time ( $t_A$ )	$\leq 25$ ns
Max. mains-side overcurrent protection	125 A gG
Short-circuit withstand capability for max. mains-side overcurrent protection ( $I_{SCCR}$ )	50 kA <sub>rms</sub>
Temporary overvoltage (TOV) ( $U_T$ ) – Characteristic	175 V / 5 sec. – withstand
Temporary overvoltage (TOV) ( $U_T$ ) – Characteristic	230 V / 120 min. – safe failure
Operating temperature range ( $T_U$ )	-40 °C ... +80 °C
Operating state / fault indication	green / red
Number of ports	1
Cross-sectional area (min.)	1.5 mm <sup>2</sup> solid / flexible
Cross-sectional area (max.)	35 mm <sup>2</sup> stranded / 25 mm <sup>2</sup> flexible
For mounting on	35 mm DIN rails acc. to EN 60715
Enclosure material	thermoplastic, red, UL 94 V-0
Place of installation	indoor installation
Degree of protection	IP 20
Capacity	1 module(s), DIN 43880
Approvals	KEMA, VDE, UL, VdS, CSA
Type of remote signalling contact	changeover contact
a.c. switching capacity	250 V / 0.5 A
d.c. switching capacity	250 V / 0.1 A; 125 V / 0.2 A; 75 V / 0.5 A
Cross-sectional area for remote signalling terminals	max. 1.5 mm <sup>2</sup> solid / flexible
Weight	113 g
Customs tariff number	85363030
GTIN	4013364109865
PU	1 pc(s)

## EXFS

### EXFS 100 (923 100)

- For indirect connection / earthing of functionally isolated parts of installations under lightning conditions
- Device for lightning equipotential bonding according to IEC 62305 in hazardous areas
- Approval according to ATEX Directive 94/9/EC and IECEx



Figure without obligation

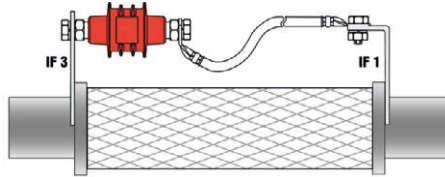

Installation of EXFS 100

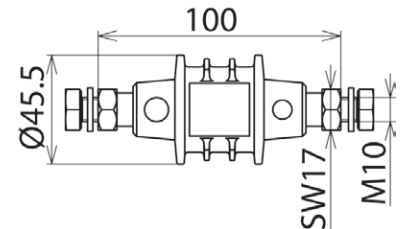

Dimension drawing EXFS 100

Isolating spark gap for use in hazardous areas with plastic sheath and M10 threaded screws.

Type	EXFS 100
Part No.	923 100
Isolating spark gap according to EN 62561-3 / IEC 62561-3	yes
Lightning impulse current (10/350 µs) ( $I_{imp}$ )	100 kA
Class (lightning current carrying capability)	H
Rated power-frequency withstand voltage (50 / 60 Hz) ( $U_{wAC}$ )	250 V
Rated impulse sparkover voltage ( $U_{r,imp}$ )	≤ 1.25 kV
Operating temperature range ( $T_U$ )	-20 °C ... +60 °C
Degree of protection	IP 67
ATEX approvals	DEKRA 11ATEX0178 X
Ex marking according to EN 60079-0 and EN 60079-1: gas	II 2 G Ex d IIC T6 Gb
Ex marking according to EN 60079-0 and EN 60079-31: dust	II 2 D Ex tb IIIC T80 °C Db IP 66/67
IECEx approvals	IECEx KEM 09.0051X
Ex marking according to EN 60079-0 and EN 60079-1: gas	Ex d IIC T6 Gb
Ex marking according to EN 60079-0 and EN 60079-31: dust	Ex tb IIIC T80 °C Db IP 66/67
Enclosure length	100 mm
Enclosure diameter	45.5 mm
Enclosure material	plastic sheath
Connection of enclosure	M10 threaded bushing, 2x M10x25 mm, 2x spring washer
Extended technical data:	-----
- Rated discharge current (50 / 60 Hz) ( $I_{max}$ )	500 A / 0.2 sec.
- Noimnal discharge current (8/20 µs) ( $I_n$ )	100 kA
- Power frequency sparkover voltage (50 / 60 Hz) ( $U_{sw}$ )	≤ 0.5 kV
Weight	289 g
Customs tariff number	85369085
GTIN	4013364108325
PU	1 pc(s)

## EXFS

### EXFS 100 KU (923 101)

- For indirect connection / earthing of functionally isolated parts of installations under lightning conditions
- Device for lightning equipotential bonding according to IEC 62305 in hazardous areas
- Approval according to ATEX Directive 94/9/EC and IECEx



Figure without obligation

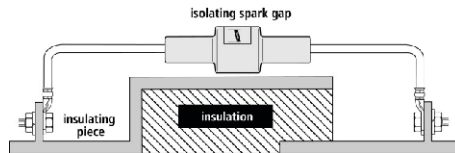

Installation of EXFS 100 KU

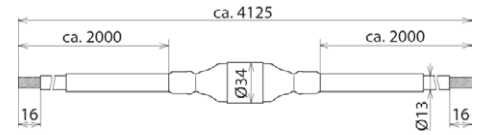

Dimension drawing EXFS 100 KU

Ex isolating spark gap with connecting cable for aboveground and underground installation; with water-proof sheath; may be shortened for short connecting cables.

Type Part No.	EXFS 100 KU 923 101
Isolating spark gap according to EN 62561-3 / IEC 62561-3	yes
Lightning impulse current (10/350 µs) ( $I_{imp}$ )	100 kA
Class (lightning current carrying capability)	H
Rated power-frequency withstand voltage (50 / 60 Hz) ( $U_{wAC}$ )	250 V
Rated impulse sparkover voltage ( $U_{r,imp}$ )	≤ 1.25 kV
Operating temperature range ( $T_U$ )	-40 °C ... +60 °C
Temperature range during installation	-5 °C ... +50 °C
Degree of protection	IP 67
ATEX approvals	DEKRA 11ATEX0178 X
Ex marking according to EN 60079-0 and EN 60079-1: gas	II 2 G Ex d IIC T6 Gb
Ex marking according to EN 60079-0 and EN 60079-31: dust	II 2 D Ex tb IIIC T80 °C Db IP 66/67
IECEx approvals	IECEx KEM 09.0051X
Ex marking according to EN 60079-0 and EN 60079-1: gas	Ex d IIC T6 Gb
Ex marking according to EN 60079-0 and EN 60079-31: dust	Ex tb IIIC T80°C Db IP 66/67
Enclosure length	123 mm
Enclosure diameter	34 mm
Enclosure material	water-proof plastic sheath
Connection of enclosure	NYJ-J-1x25 mm <sup>2</sup>
Cable length	2x approx. 2000 mm
Extended technical data:	-----
- Rated discharge current (50 / 60 Hz) ( $I_{max}$ )	500 A / 0.2 sec.
- Noimnal discharge current (8/20 µs) ( $I_n$ )	100 kA
- Power frequency sparkover voltage (50 / 60 Hz) ( $U_{sw}$ )	≤ 0.5 kV
Weight	1,98 kg
Customs tariff number	85369085
GTIN	4013364108332
PU	1 pc(s)

## Modular wiring system

### MVS 1 2 (900 617)

- Allows compact connection of arresters with each other and with other DIN rail mounted devices

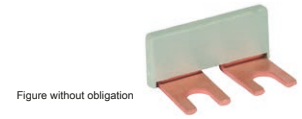

Figure without obligation

Type Part No.	MVS 1 2 900 617
Type	single-phase
Number of contact studs	2
Max. installation length	2 module(s)
Nominal cross-section	16 mm <sup>2</sup>
Weight	9 g
Customs tariff number	85369085
GTIN	4013364086593
PU	1 pc(s)

## BLITZDUCTOR XT

### BXT BAS (920 300)

- Four-pole version for universal use with all types of BSP and BXT / BXTU protection modules
- No signal interruption if the protection module is removed
- Universal design without protection elements



Figure without obligation

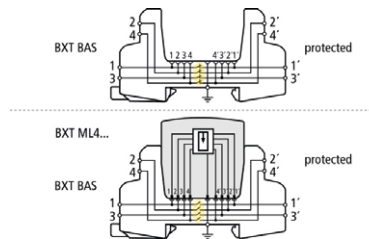

Basic circuit diagram with and without plugged-in module

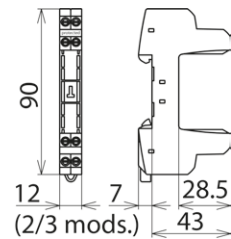

Dimension drawing BXT BAS

The BLITZDUCTOR XT base part is a very space-saving and universal four-pole feed-through terminal for the insertion of a protection module without signal interruption if the protection module is removed. The snap-in mechanism at the supporting foot of the base part allows the protection module to be safely earthed via the DIN rail. Since no components of the protective circuit are situated in the base part, only the protection modules must be maintained.

Type Part No.	BXT BAS 920 300
Operating temperature range (T <sub>U</sub> )	-40 °C ... +80 °C
Degree of protection	IP 20
For mounting on	35 mm DIN rails acc. to EN 60715
Connection (input / output)	screw / screw
Signal disconnection	no
Cross-sectional area, solid	0.08-4 mm <sup>2</sup>
Cross-sectional area, flexible	0.08-2.5 mm <sup>2</sup>
Tightening torque (terminals)	0.4 Nm
Earthing via	35 mm DIN rails acc. to EN 60715
Enclosure material	polyamide PA 6.6
Colour	yellow
ATEX approvals	DEKRA 11ATEX0089 X: II 3 G Ex nA IIC T4 Gc <sup>*)</sup>
IECEx approvals	DEK 11.0032X: Ex nA IIC T4 Gc <sup>*)</sup>
Approvals	CSA, VdS, UL, GOST
Weight	34 g
Customs tariff number	85369010
GTIN	4013364109179
PU	1 pc(s)

<sup>\*)</sup> only in connection with an approved protection module



## BLITZDUCTOR XT

### BXT ML2 BD 180 (920 247)

- LifeCheck SPD monitoring function
- Optimal protection of one pair
- For installation in conformity with the lightning protection zone concept at the boundaries from  $0_A-2$  and higher



Figure without obligation

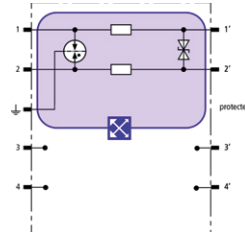

Basic circuit diagram BXT ML2 BD 180

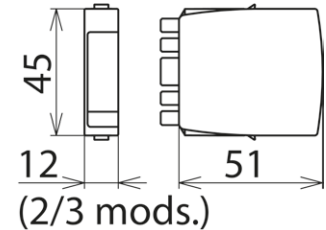

Dimension drawing BXT ML2 BD 180

Space-saving combined lightning current and surge arrester module with LifeCheck feature for protecting one pair of unearthed balanced interfaces. If LifeCheck detects thermal or electrical overload, the arrester has to be replaced. This status is indicated contactlessly by the DEHNrecord LC / SCM / MCM reader.

Type	BXT ML2 BD 180
Part No.	920 247
SPD monitoring system	LifeCheck
SPD class	<b>TYPE 1P2</b>
Nominal voltage ( $U_N$ )	180 V
Max. continuous operating d.c. voltage ( $U_c$ )	180 V
Max. continuous operating a.c. voltage ( $U_c$ )	127 V
Nominal current at 45 °C ( $I_L$ )	0.75 A
D1 Total lightning impulse current (10/350 $\mu$ s) ( $I_{imp}$ )	5 kA
D1 Lightning impulse current (10/350 $\mu$ s) per line ( $I_{imp}$ )	2.5 kA
C2 Total nominal discharge current (8/20 $\mu$ s) ( $I_n$ )	20 kA
C2 Nominal discharge current (8/20 $\mu$ s) per line ( $I_n$ )	10 kA
Voltage protection level line-line for $I_{imp}$ D1 ( $U_p$ )	$\leq 270$ V
Voltage protection level line-PG for $I_{imp}$ D1 ( $U_p$ )	$\leq 550$ V
Voltage protection level line-line at 1 kV/ $\mu$ s C3 ( $U_p$ )	$\leq 250$ V
Voltage protection level line-PG at 1 kV/ $\mu$ s C3 ( $U_p$ )	$\leq 550$ V
Series resistance per line	1.8 ohm(s)
Cut-off frequency line-line ( $f_c$ )	25.0 MHz
Capacitance line-line (C)	$\leq 240$ pF
Capacitance line-PG (C)	$\leq 16$ pF
Operating temperature range ( $T_U$ )	-40 °C ... +80 °C
Degree of protection (plugged-in)	IP 20
Pluggable into	BXT BAS / BSP BAS 4 base part
Earthing via	BXT BAS / BSP BAS 4 base part
Enclosure material	polyamide PA 6.6
Colour	yellow
Test standards	IEC 61643-21 / EN 61643-21, UL 497B
SIL classification	up to SIL3 <sup>*)</sup>
ATEX approvals	DEKRA 11ATEX0089 X: II 3 G Ex nA IIC T4 Gc
IECEx approvals	DEK 11.0032X: Ex nA IIC T4 Gc
CSA & USA Hazloc approvals (1)	2516389: Class I Div. 2 GP A, B, C, D T4
CSA & USA Hazloc approvals (2)	2516389: Class I Zone 2, AEx nA IIC T4
Approvals	CSA, GOST, VdS
Weight	43 g
Customs tariff number	85363010
GTIN	4013364116078
PU	1 pc(s)

<sup>\*)</sup> For more detailed information, please visit [www.dehn-international.com](http://www.dehn-international.com).

## BLITZDUCTOR XT

### BXT ML4 BD 180 (920 347)

- LifeCheck SPD monitoring function
- Optimal protection of two pairs
- For installation in conformity with the lightning protection zone concept at the boundaries from  $0_A -2$  and higher



Figure without obligation

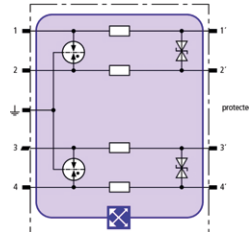

Basic circuit diagram BXT ML4 BD 180

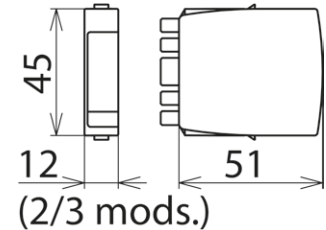

Dimension drawing BXT ML4 BD 180

Space-saving combined lightning current and surge arrester module with LifeCheck feature for protecting two pairs of unearthed balanced interfaces. If LifeCheck detects thermal or electrical overload, the arrester has to be replaced. This status is indicated contactlessly by the DEHNrecord LC / SCM / MCM reader.

Type	BXT ML4 BD 180
Part No.	920 347
SPD monitoring system	LifeCheck
SPD class	<b>TYPE 1P2</b>
Nominal voltage ( $U_N$ )	180 V
Max. continuous operating d.c. voltage ( $U_c$ )	180 V
Max. continuous operating a.c. voltage ( $U_c$ )	127 V
Nominal current at 45 °C ( $I_L$ )	0.75 A
D1 Total lightning impulse current (10/350 $\mu$ s) ( $I_{imp}$ )	10 kA
D1 Lightning impulse current (10/350 $\mu$ s) per line ( $I_{imp}$ )	2.5 kA
C2 Total nominal discharge current (8/20 $\mu$ s) ( $I_n$ )	20 kA
C2 Nominal discharge current (8/20 $\mu$ s) per line ( $I_n$ )	10 kA
Voltage protection level line-line for $I_{imp}$ D1 ( $U_p$ )	$\leq 270$ V
Voltage protection level line-PG for $I_{imp}$ D1 ( $U_p$ )	$\leq 550$ V
Voltage protection level line-line at 1 kV/ $\mu$ s C3 ( $U_p$ )	$\leq 250$ V
Voltage protection level line-PG at 1 kV/ $\mu$ s C3 ( $U_p$ )	$\leq 550$ V
Series resistance per line	1.8 ohm(s)
Cut-off frequency line-line ( $f_c$ )	25.0 MHz
Capacitance line-line (C)	$\leq 240$ pF
Capacitance line-PG (C)	$\leq 16$ pF
Operating temperature range ( $T_U$ )	-40 °C ... +80 °C
Degree of protection (plugged-in)	IP 20
Pluggable into	BXT BAS / BSP BAS 4 base part
Earthing via	BXT BAS / BSP BAS 4 base part
Enclosure material	polyamide PA 6.6
Colour	yellow
Test standards	IEC 61643-21 / EN 61643-21, UL 497B
SIL classification	up to SIL3 <sup>*)</sup>
ATEX approvals	DEKRA 11ATEX0089 X: II 3 G Ex nA IIC T4 Gc
IECEx approvals	DEK 11.0032X: Ex nA IIC T4 Gc
CSA & USA Hazloc approvals (1)	2516389: Class I Div. 2 GP A, B, C, D T4
CSA & USA Hazloc approvals (2)	2516389: Class I Zone 2, AEx nA IIC T4
Approvals	CSA, VdS, UL, GOST
Weight	24 g
Customs tariff number	85363010
GTIN	4013364109018
PU	1 pc(s)

<sup>\*)</sup>For more detailed information, please visit [www.dehn-international.com](http://www.dehn-international.com).

## BLITZDUCTOR XT

### BXT BAS EX (920 301)

- Four-pole and universal base part for all types of intrinsically safe protection modules
- No signal interruption if the protection module is removed
- Universal design without protection elements



Figure without obligation

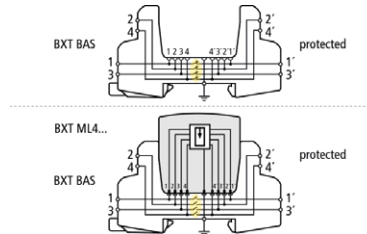

Basic circuit diagram with and without module

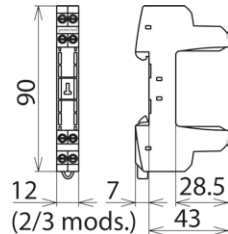

Dimension drawing BXT BAS EX

BLITZDUCTOR XT base part for use as an extremely space-saving and universal four-pole feed-through terminal for intrinsically safe circuits for the insertion of the protection module, no signal disconnection if the protection module is removed. The snap-in mechanism at the supporting foot of the base part allows the device to be safely earthed via the DIN rail. Since no components of the protective circuit are situated in the base part, only the protection modules must be maintained.

Type Part No.	BXT BAS EX 920 301
Operating temperature range	-40 °C ... +80 °C
Degree of protection	IP 20
For mounting on	35 mm DINs rails acc. to EN 60715
Connection (input / output)	screw / screw
Cross-sectional area, solid	0.08-4 mm <sup>2</sup>
Cross-sectional area, flexible	0.08-2.5 mm <sup>2</sup>
Tightening torque (terminals)	0.4 Nm
Earthing via	35 mm DIN rails acc. to EN 60715
Enclosure material	polyamide PA 6.6
Colour	blue
ATEX approvals (1)	KEMA 06ATEX0274 X: II 2 (1) G Ex ia [ia Ga] IIC T4 ... T6 Gb *)
ATEX approvals (2)	KEMA 06ATEX0274 X: II 2 G Ex ib IIC T4 ... T6, Gb *)
IECEX approvals (1)	DEK 11.0078X: Ex ia [ia Ga] IIC T4 ... T6 Gb *)
IECEX approvals (2)	DEK 11.0078X: Ex ib IIC T4 ... T6 Gb *)
CSA & USA Hazloc approvals (1)	70000011: Class I Div. 1; Class I Zone 1
CSA & USA Hazloc approvals (2)	70000011: Ex ia [ia] IIC T4 ... T6
Approvals	UL, CSA, GOST
Weight	53 g
Customs tariff number	85369010
GTIN	4013364109186
PU	1 pc(s)

\*) only in connection with an approved protection module

## BLITZDUCTOR XT

### BXT ML2 BD S EX 24 (920 280)

- For universal use, with LifeCheck monitoring function
- Self-capacitance and self-inductance negligibly small
- For installation in conformity with the lightning protection zone concept at the boundaries from  $0_b-2$  and higher



Figure without obligation

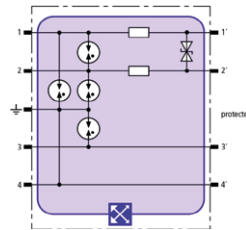

Basic circuit diagram BXT ML2 BD S EX 24

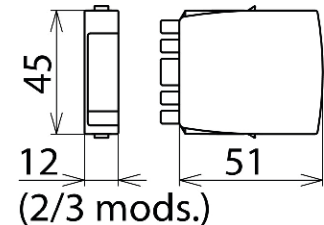

Dimension drawing BXT ML2 BD S EX 24

Space-saving surge arrester module with LifeCheck feature for protecting one pair of intrinsically safe measuring circuits and bus systems, direct or indirect shield earthing. Insulation strength > 500 V line-earth.

If LifeCheck detects thermal or electrical overload, the arrester has to be replaced. This status is indicated contactlessly by DEHNrecord LC / SCM / MCM.

Type	BXT ML2 BD S EX 24
Part No.	920 280
SPD class	TYPE 2 Pt
SPD monitoring	LifeCheck
Nominal voltage ( $U_N$ )	24 V
Max. continuous operating d.c. voltage ( $U_c$ )	33 V
Max. continuous operating a.c. voltage ( $U_c$ )	23.3 V
Max. input voltage acc. to EN 60079-11 ( $U_i$ )	30 V
Max. input current acc. to EN 60079-11 ( $I_i$ )	0.5 A
D1 Total lightning impulse current (10/350 $\mu$ s) ( $I_{imp}$ )	4 kA
D1 Lightning impulse current (10/350 $\mu$ s) per line ( $I_{imp}$ )	1 kA
C2 Total nominal discharge current (8/20 $\mu$ s) ( $I_n$ )	10 kA
C2 Nominal discharge current (8/20 $\mu$ s) per line ( $I_n$ )	5 kA
Voltage protection level line-line for $I_{imp}$ D1 ( $U_p$ )	$\leq 50$ V
Voltage protection level line-PG for $I_{imp}$ D1 ( $U_p$ )	$\leq 1300$ V
Voltage protection level line-line for $I_n$ C2 ( $U_p$ )	$\leq 52$ V
Voltage protection level line-PG for $I_n$ C2 ( $U_p$ )	$\leq 1400$ V
Voltage protection level line-line at 1 kV/ $\mu$ s C3 ( $U_p$ )	$\leq 45$ V
Voltage protection level line-PG at 1 kV/ $\mu$ s C3 ( $U_p$ )	$\leq 1100$ V
Series resistance per line	1.0 ohm
Cut-off frequency line-line ( $f_c$ )	6 MHz
Capacitance line-line (C)	$\leq 1.0$ nF
Capacitance line-PG (C)	$\leq 16$ pF
Operating temperature range ( $T_U$ )	-40 °C ... +80 °C
Degree of protection (plugged-in)	IP 20
Plugs into	base part
Earthing via	base part
Enclosure material	polyamide PA 6.6
Colour	blue
Test standards	IEC 61643-21 / EN 61643-21
ATEX approvals (1)	KEMA 06ATEX0274 X: II 2 (1) G Ex ia [ia Ga] IIC T4 ... T6 Gb
ATEX approvals (2)	KEMA 06ATEX0274 X: II 2 G Ex ib IIC T4 ... T6 Gb
IECEx approvals (1)	DEK 11.0078X: Ex ia [ia Ga] IIC T4 ... T6 Gb
IECEx approvals (2)	DEK 11.0078X: Ex ib IIC T4 ... T6 Gb
CSA & USA Hazloc approvals (1)	70000011: Class I Div. 1; Class I Zone 1
CSA & USA Hazloc approvals (2)	70000011: Ex ia [ia] IIC T4 ... T6
Approvals	GOST
Weight	22 g
Customs tariff number	85363010
GTIN	4013364142138
PU	1 pc(s)

## BLITZDUCTOR XT

### BXT ML4 BD EX 24 (920 381)

- For universal use, with LifeCheck monitoring function
- Self-capacitance and self-inductance negligibly small
- For installation in conformity with the lightning protection zone concept at the boundaries from  $0_B-2$  and higher



Figure without obligation

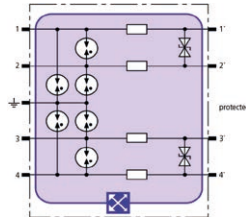

Basic circuit diagram BXT ML4 BD EX 24

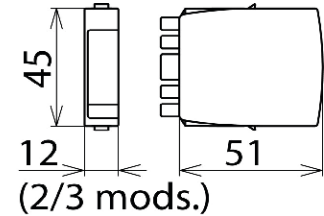

Dimension drawing BXT ML4 BD EX 24

Space-saving surge arrester module with LifeCheck feature for protecting two pairs of intrinsically safe measuring circuits and bus systems, meets FISCO requirements. ATEX. Insulation strength > 500 V line-earth.

If LifeCheck detects thermal or electrical overload, the arrester has to be replaced. This status is indicated contactlessly by DEHNrecord LC / SCM / MCM.

Type	BXT ML4 BD EX 24
Part No.	920 381
SPD class	TYPE 2P <sup>*)</sup>
SPD monitoring	LifeCheck
Nominal voltage ( $U_N$ )	24 V
Max. continuous operating d.c. voltage ( $U_c$ )	33 V
Max. continuous operating a.c. voltage ( $U_e$ )	23 V
Max. input voltage acc. to EN 60079-11 ( $U_i$ )	30 V
Max. input current acc. to EN 60079-11 ( $I_i$ )	0.5 A
D1 Total lightning impulse current (10/350 $\mu$ s) ( $I_{imp}$ )	4 kA
D1 Lightning impulse current (10/350 $\mu$ s) per line ( $I_{imp}$ )	1 kA
C2 Total nominal discharge current (8/20 $\mu$ s) ( $I_n$ )	20 kA
C2 Nominal discharge current (8/20 $\mu$ s) per line ( $I_n$ )	5 kA
Voltage protection level line-line for $I_{imp}$ D1 ( $U_p$ )	$\leq 50$ V
Voltage protection level line-PG for $I_{imp}$ D1 ( $U_p$ )	$\leq 1300$ V
Voltage protection level line-line for $I_n$ C2 ( $U_p$ )	$\leq 52$ V
Voltage protection level line-PG for $I_n$ C2 ( $U_p$ )	$\leq 1400$ V
Voltage protection level line-line at 1 kV/ $\mu$ s C3 ( $U_p$ )	$\leq 45$ V
Voltage protection level line-PG at 1 kV/ $\mu$ s C3 ( $U_p$ )	$\leq 1100$ V
Series resistance per line	1.0 ohm
Cut-off frequency line-line ( $f_c$ )	7.7 MHz
Capacitance line-line (C)	$\leq 0.8$ nF
Capacitance line-PG (C)	$\leq 16$ pF
Operating temperature range ( $T_U$ )	-40 °C ... +80 °C
Degree of protection (plugged-in)	IP 20
Plugs into	base part
Earthing via	base part
Enclosure material	polyamide PA 6.6
Colour	blue
Test standards	IEC 61643-21 / EN 61643-21, UL 497B
SIL classification	up to SIL3 <sup>*)</sup>
ATEX approvals (1)	KEMA 06ATEX0274 X: II 2 (1) G Ex ia [ia Ga] IIC T4 ... T6 Gb
ATEX approvals (2)	KEMA 06ATEX0274 X: II 2 G Ex ib IIC T4 ... T6 Gb
IECEx approvals (1)	DEK 11.0078X: Ex ia [ia Ga] IIC T4 ... T6 Gb
IECEx approvals (2)	DEK 11.0078X: Ex ib IIC T4 ... T6 Gb
CSA & USA Hazloc approvals (1)	70000011: Class I Div. 1; Class I Zone 1
CSA & USA Hazloc approvals (2)	70000011: Ex ia [ia] IIC T4 ... T6
Approvals	CSA, GOST
Weight	23 g
Customs tariff number	85363010
GTIN	4013364109025
PU	1 pc(s)

<sup>\*)</sup> For more detailed information, please visit [www.dehn-international.com](http://www.dehn-international.com).

## BLITZDUCTOR VT

### BVT KKS ALD 75 (918 420)

- For protective circuits
- High nominal current
- For installation in conformity with the lightning protection zone concept at the boundaries from  $0_A - 2$  and higher



Figure without obligation

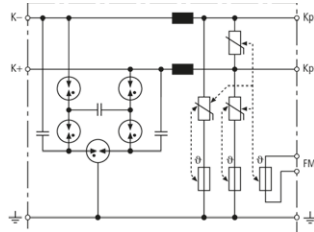

Basic circuit diagram BVT KKS ALD 75

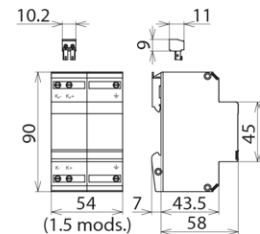

Dimension drawing BVT KKS ALD 75

Energy-coordinated combined lightning current and surge arrester for protecting the rectifier in the protective circuit (red colour). Plug-in remote signalling contact (break contact) indicates overload (thermal monitoring of the varistors). Installation into steel-sheet enclosure recommended. A low impulse sparkover voltage is achieved by capacitive control.

Type Part No.	BVT KKS ALD 75 918 420
SPD class	<b>TYPE I</b> P
Nominal voltage ( $U_N$ )	70 V
Max. continuous operating d.c. voltage ( $U_c$ )	75 V
Nominal current ( $I_L$ )	12 A
D1 Total lightning impulse current (10/350 $\mu$ s) ( $I_{imp}$ )	7 kA
D1 Lightning impulse current (10/350 $\mu$ s) per line ( $I_{imp}$ )	3.5 kA
C2 Total nominal discharge current (8/20 $\mu$ s) ( $I_n$ )	40 kA
C2 Nominal discharge current (8/20 $\mu$ s) per line ( $I_n$ )	20 kA
Voltage protection level line-line for $I_{imp}$ D1 ( $U_p$ )	$\leq 400$ V
Voltage protection level line-PG for $I_{imp}$ D1 ( $U_p$ )	$\leq 400$ V
Voltage protection level line-line at 1 kV/ $\mu$ s C3 ( $U_p$ )	$\leq 350$ V
Voltage protection level line-PG at 1 kV/ $\mu$ s PG ( $U_p$ )	$\leq 350$ V
A2 Total alternating current withstand capability	20 A
Series resistance per line	5 $\mu$ H
Cut-off frequency line-line ( $f_c$ )	1 MHz
Capacitance line-line (C)	$\leq 2$ nF
Capacitance line-PG (C)	$\leq 2$ nF
Operating temperature range ( $T_U$ )	-40 °C ... +80 °C
Degree of protection	IP 20
For mounting on	35 mm DIN rails acc. to EN 60715
Connection (input / output)	screw / screw
Cross-sectional area, solid	0.5-6 mm <sup>2</sup>
Cross-sectional area, flexible	0.5-4 mm <sup>2</sup>
Tightening torque (terminal)	0.8 Nm
Earthing via	screw terminal
Enclosure material	thermoplastic, UL 94 V-0
Colour	red
Test standards	IEC 61643-21 / EN 61643-21
Approvals	GOST
Type of remote signalling contacts	break contact
d.c. switching capacity	250 V / 0.1 A, 125 V / 0.2 A, 75 V / 0.5 A
a.c. switching capacity	250 V / 0.5 A
Cross-sectional area for remote signalling terminals	max 1.5 mm <sup>2</sup>
Weight	212 g
Customs tariff number	85363010
GTIN	4013364094895
PU	1 pc(s)

## BLITZDUCTOR VT

### BVT KKS APD 36 (918 421)

- For voltage measuring circuits
- Plug-in remote signalling contact
- For installation in conformity with the lightning protection zone concept at the boundaries from  $0_A - 2$  and higher



Figure without obligation

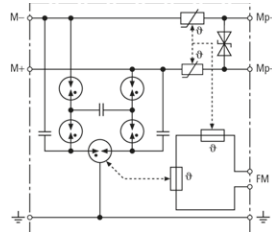

Basic circuit diagram BVT KKS APD 36

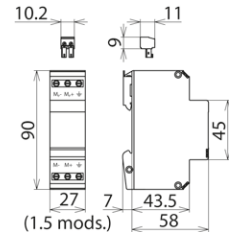

Dimension drawing BVT KKS APD 36

Energy-coordinated combined lightning current and surge arrester for protecting voltage measuring circuits (yellow colour). Plug-in remote signalling contact (break contact) indicates overload (thermal monitoring of the discharge paths). Installation into steel-sheet enclosure recommended. A low impulse sparkover voltage is achieved by capacitive control.

Type	BVT KKS APD 36
Part No.	918 421
SPD class	<b>TYPE 1 P1</b>
Nominal voltage ( $U_N$ )	36 V
Max. continuous operating d.c. voltage ( $U_c$ )	36.8 V
Nominal current ( $I_L$ )	0.05 A
D1 Total lightning impulse current (10/350 $\mu$ s) ( $I_{imp}$ )	7 kA
D1 Lightning impulse current (10/350 $\mu$ s) per line ( $I_{imp}$ )	3.5 kA
C2 Total nominal discharge current (8/20 $\mu$ s) ( $I_n$ )	40 kA
C2 Nominal discharge current (8/20 $\mu$ s) per line ( $I_n$ )	20 kA
Voltage protection level line-line for $I_{imp}$ D1 ( $U_p$ )	$\leq 65$ V
Voltage protection level line-PG for $I_{imp}$ D1 ( $U_p$ )	$\leq 800$ V
Voltage protection level line-line at 1 kV/ $\mu$ s C3 ( $U_p$ )	$\leq 48$ V
Voltage protection level line-PG at 1 kV/ $\mu$ s PG ( $U_p$ )	$\leq 600$ V
A2 Total alternating current withstand capability	20 A
Series resistance per line	70 ohms
Cut-off frequency line-line ( $f_c$ )	4.5 dB at 1 MHz (100 ohms)
Capacitance line-line (C)	$\leq 1$ nF
Capacitance line-PG (C)	$\leq 10$ pF
Operating temperature range ( $T_U$ )	-40 °C ... +80 °C
Degree of protection	IP 20
For mounting on	35 mm DIN rails acc. to EN 60715
Connection (input / output)	screw / screw
Cross-sectional area, solid	0.5 mm-6 mm <sup>2</sup>
Cross-sectional area, flexible	0.5 mm-4 mm <sup>2</sup>
Tightening torque (terminal)	0.8 Nm
Earthing via	screw terminal
Enclosure material	thermoplastic, UL 94 V-0
Colour	yellow
Test standards	IEC 61643-21 / EN 61643-21
Approvals	GOST
Type of remote signalling contacts	break contact
d.c. switching capacity	250 V / 0.1 A, 125 V / 0.2 A, 75 V / 0.5 A
a.c. switching capacity	250 V / 0.5 A
Cross-sectional area for remote signalling terminals	max. 1.5 mm <sup>2</sup>
Weight	118 g
Customs tariff number	85363010
GTIN	4013364094901
PU	1 pc(s)

Air-termination masts for sub-roof installation of the HVI conductor

HVI I 20 L6M SR1950 FS2500 UD AL (819 245)

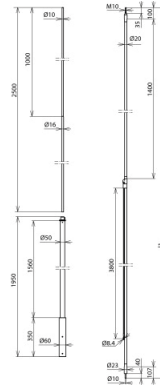

Figure without obligation

Part No.	819 245
Material of supporting tube	GRP / Al
Supporting tube Ø GRP	50 mm
Length of supporting tube	1950 mm
Diameter Ø of conductor	20 mm
Colour of conductor	black •
Colour RAL	similar 9011
Material of conductor	Cu
Supporting tube Ø Al	60 mm
Cross section of core	19 mm <sup>2</sup>
Equivalent separation distance s (in air)	≤ 75 cm
Material of insulation	PE
Material of sheath	PVC
Characteristics of sheath	UV stabilised and weather resistant
Connection diameter	10 mm
EB connection conductor	H07RN-F (6 mm <sup>2</sup> )
Cable lug	8-6 (Cu/Sn)
Material of connection elements	StSt
Material of EB connection element	StSt
Minimum order length	6 m
Max. gust wind speed	145 km/h
Weight	7,4 kg
Customs tariff number	85389099
GTIN	4013364135796
PU	1 pc(s)



## Supporting Tube with HVI Conductor

### HVI 20 L6M SR3200 IP FSP1000 GFK AL (819 326)



Abbildung unverbindlich

Mit innenliegendem Endverschluss und Fangspitze NIRO Ø10 mm, Länge 1000 mm.

Art.-Nr.	819 326
Werkstoff Fangspitze	NIRO
Länge Fangspitze	1000 mm
Werkstoff Stützrohr	GFK / Al
Länge Stützrohr	3200 mm
Transportlänge	3200 mm
Durchmesser Ø Leitung	20 mm
Farbe Leitung	schwarz •
Werkstoff Leiter	Cu
Farbe RAL	ähnlich 9011
Querschnitt Seele (ein- / mehrdrähtig)	19 mm <sup>2</sup>
Äquivalenter Trennungsabstand s (in Luft)	≤ 75 cm
Werkstoff Isolierung	PE
Werkstoff Mantel	PVC
Manteleigenschaften	UV-stabilisiert und witterungsbeständig
Anschlussdurchmesser	10 mm
Werkstoff Anschusselemente	NIRO
Stützrohr	50 x 4 mm
Mindestbestelllänge	6 m
Max. freie Länge mit Fangspitze (Wandmontage)	3500 mm
Max. Böenwindgeschwindigkeit (Wandmontage, 1x HVI innen)	237 km/h
Max. Böenwindgeschwindigkeit (Wandmontage, 1x HVI außen)	227 km/h
Max. Böenwindgeschwindigkeit (Wandmontage, 4x HVI außen)	197 km/h
Gewicht	8,7 kg
Zolltarifnummer	85389099
GTIN (EAN)	4013364241015
VPE	1 Stk.

Mounting bracket for use at rafters

DASH D48 AS600.750 STTZN (105 240)

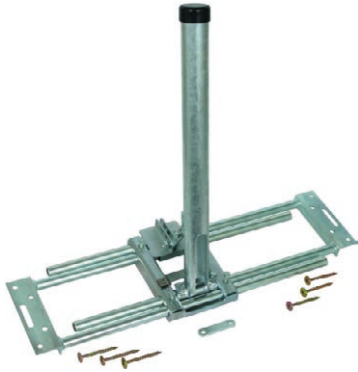
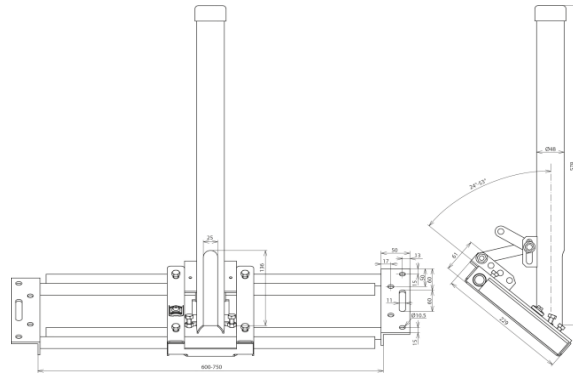

Figure without obligation



Part No.	105 240
Material	St/tZn
Adjustment range	600-750 mm
Roof pitch	24°-53°
Diameter Ø of supporting tube	48 mm
Diameter Ø of cable bushing in supporting tube	25 mm
Fixing screw	⌀ 8 x 120 mm
Weight	7,23 kg
Customs tariff number	73089098
GTIN	4013364135116
PU	1 pc(s)

Supports for air-termination rods

BS D40.50 D48.60 V2A (105 354)



Figure without obligation

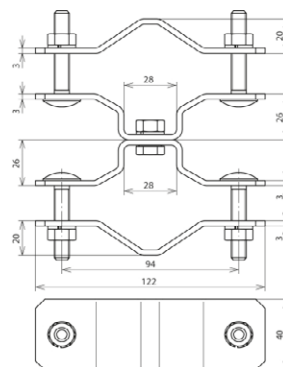

Part No.	105 354
Material	StSt
Clamping range Ø of pipe	48-60 mm (1 1/2-2")
Clamping range of air-termination rod	40-50 mm
Material of screw	StSt
Weight	617 g
Customs tariff number	85389099
GTIN	4013364098725

## Roof bushing kit

- For bushing and sealing of poles and pipes on steep roofs
  - For universal use with different roof tiles/roof stones due to formable aluminium roof tile
- Roof bushing kit comprising aluminium roof tile, rubber grommet and sealing tape



Part No.	105 245
Material of roof tile	aluminium, with UV stabilised plastic coating
Dimension of roof tile	450 x 500 mm
Mast hole Ø	10 / 16 / 48 mm
Roof inclination	24° - 53°
Material of rubber grommet	UV stabilised rubber mixture
Material of sealing tape	rubber based plastical sealant
Type of sealing tape	strongly adhesive, self-welding
Dimension of sealing tape	600 x 80 mm
Processing temperature	+5 to +40 °C
Permanent temperature range of sealing tape	-40 to +80 °C
Colour	black
Weight	1,16 kg
Customs tariff number	76109090
GTIN	4013364135383
PU	1 pc(s)

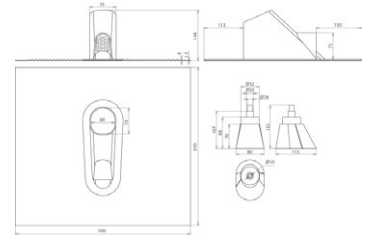

## Tripod for Supporting Tubes

### DBS KB D40.50 RA560 STTZN (105 351)



Figure without obligation

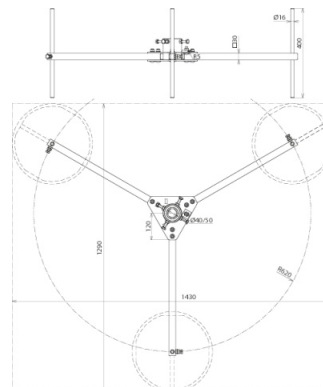

Part No.	105 351
Material of tripod	St/tZn
Support	50 mm
Radius	620 mm
Quantity of concrete bases	3-12 blocks 17 kg each
Space required for tripod	1300 x 1450 mm
Weight	11,5 kg
Customs tariff number	85389099
GTIN	4013364238916
PU	1 pc(s)

Conductor holder for CUI conductor

LH ZS 20 H10 B6.5X16 V2A (275 229)

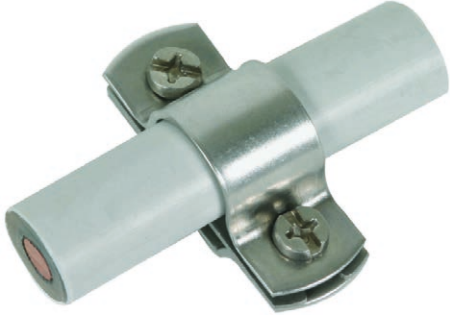
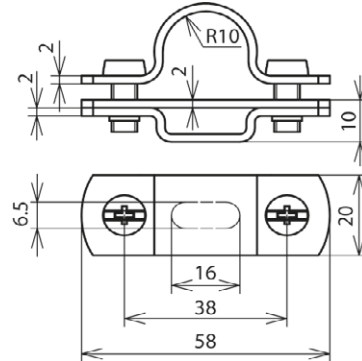

Figure without obligation



Part No.	275 229
Conductor leading	fixed
Material of screw	StSt
Material of conductor holder	StSt
Conductor holder support Rd	20 mm
Height of conductor holder	10 mm
Fixing	6.5 x 16 mm
Screw	☒ M6 x 14
Weight	59 g
Customs tariff number	85389099
GTIN	4013364102040
PU	50 pc(s)

LH ZS 20 EX AS70 BP V2A (275 440)



Figure without obligation

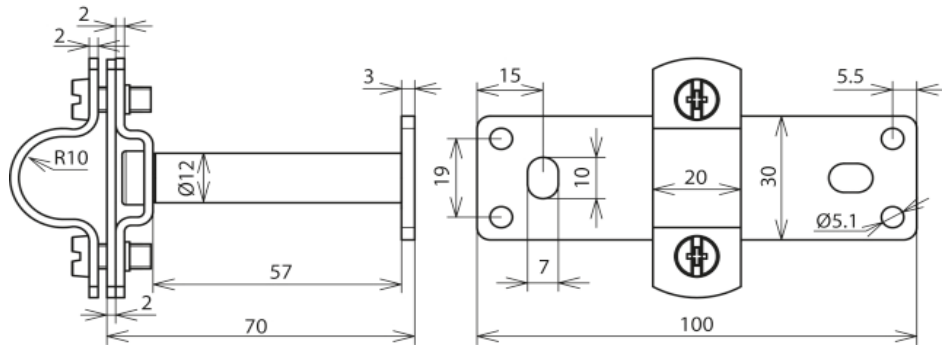

Part No.	275 440
Material	StSt
Conductor holder support Rd	20 mm
Wall distance	70 mm
Fixing	[4x] Ø5.1 / [2x] 7 x 10 mm
Screw	☒ M6 x 14 mm
Material of screw	StSt
Height of conductor holder	20 mm
Conductor leading	fixed
Female thread	M8
Weight	170 g
Customs tariff number	85389099
GTIN	4013364146914
PU	10 pc(s)

**Conductor holder for CUI conductor**

**LH ZS 20 EX AS200 BP V2A (275 441)**

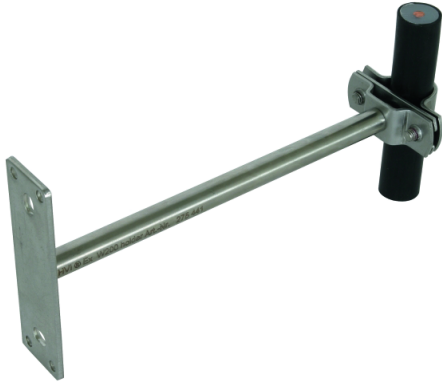

Figure without obligation



Part No.	275 441
Material	StSt
Conductor holder support Rd	20 mm
Wall distance	200 mm
Fixing	[4x] Ø5.1 / [2x] 7 x 10 mm
Screw	☿ M6 x 14 mm
Material of screw	StSt
Height of conductor holder	20 mm
Conductor leading	fixed
Female thread	M8
Weight	258 g
Customs tariff number	85389099
GTIN	4013364146921
PU	10 pc(s)

**Conductor holder for HVI conductor in ex areas**

**VS EX 500 V2A (275 498)**



Figure without obligation

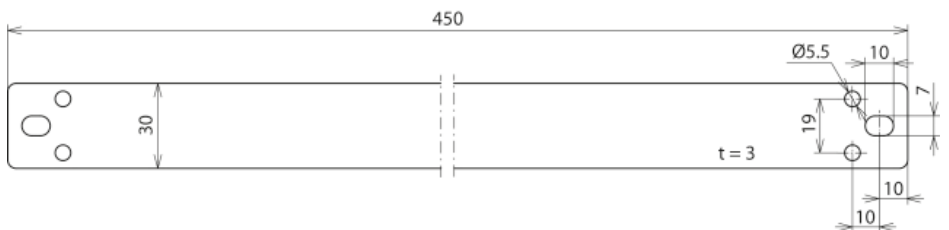

Part No.	275 498
Material of brace	StSt
Fixing	[4x] Ø5.5 / [2x] 7 x 10 mm
Dimension (l x w x d)	450 x 30 x 3 mm
Weight	320 g
Customs tariff number	85389099
GTIN	4013364146945
PU	10 pc(s)

## Roof conductor holder

With preformed bending points for angling and hooking at the tile and for screwing to the batten, for installing the HVI Conductor on saddle roofs.



Part No.	202 829
Material of roof conductor holder	StSt
Material of conductor holder	StSt
Conductor holder support Rd	20 / 23 mm
Height of conductor holder	53 mm
Conductor leading	fixed
Length of brace	205 mm
Type of roofing	pantiled roofs
Type of brace	preformed bending points
Fixing possibility	hook locking, angling, nailing
Weight	119 g
Customs tariff number	85389099
GTIN	4013364159822
PU	1 pc(s)

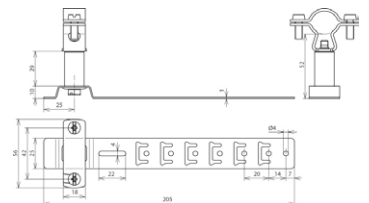

## Pipe Clamps for Antennas

### BRS 27.89 AK1X10 2X6.8 V2A (540 103)



Figure without obligation

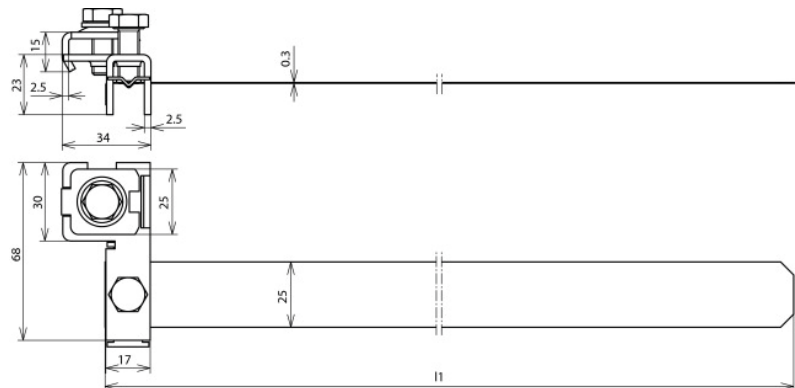

Part No.	540 103
Material	StSt
Clamping range pipe Ø	27-89 mm (1-3")
Screw	● M8 x 20 mm
Material of screw	StSt
Dimension of strap (l1 x w x d)	330 x 25 x 0.3 mm
Connection Rd	1-2 x 6-8 mm / 1 x 10 mm
Connection (solid / stranded)	4-50 mm <sup>2</sup>
Standard	EN 62561-1
Weight	120 g
Customs tariff number	85389099
Military Name	VG 96953 T05 B0001
GTIN	4013364101302
PU	10 pc(s)

## Pipe Clamps for Hazardous Areas



### EX BRS 90 (540 801)



Figure without obligation

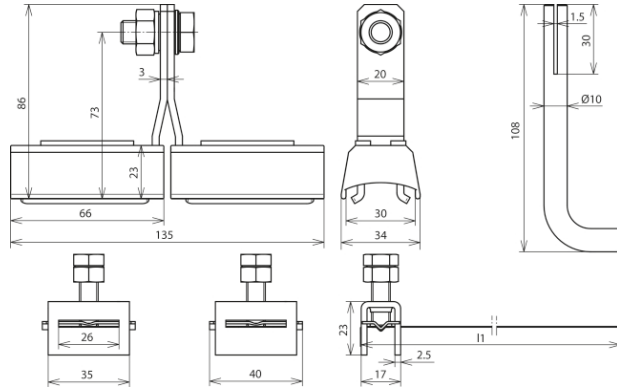

- For use in explosion-hazardous areas Ex zones 1 and 2 (gases, vapours, mists) as well as Ex zones 21 and 22 (dusts)
- Tested according to explosion group IIB
- Time-saving installation – no need to deactivate systems/areas for welding or drilling works

Part No.	540 801
Lightning impulse current (10/350 µs) Cu ( $I_{imp}$ )	50 kA
Lightning impulse current (10/350 µs) St/tZn ( $I_{imp}$ )	50 kA
Lightning impulse current (10/350 µs) StSt ( $I_{imp}$ )	25 kA
Class of lightning current carrying capability acc. to DIN EN 50164-1	N
Connection	M10
Clamping range pipe Ø	27-89 mm ( $1\frac{1}{4}$ -3")
Material of clamping body	polyamide
Material of grip head / tensioning strap	StSt
Material of contact clip	Cu/gal Sn
Dimension of tensioning strap (l1 x w x d)	410 x 25 x 0.3 mm
Design	UV stabilised
Standard	EN 62561-1
Weight	503 g
Customs tariff number	85389099
GTIN	4013364115460
PU	1 pc(s)

## Pipe Clamps for Hazardous Areas

### EX BRS 300 (540 803)

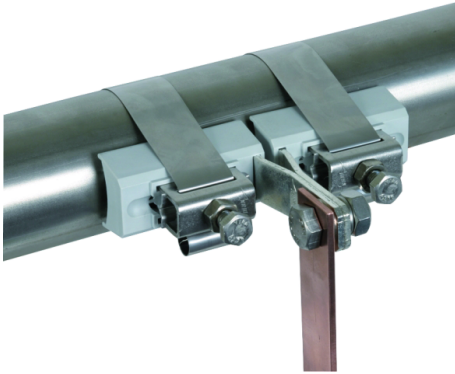
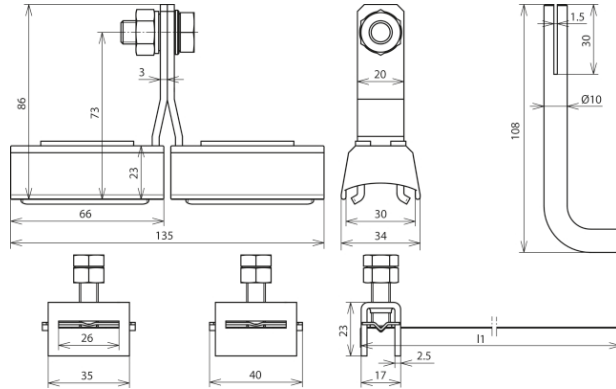

Figure without obligation



- For use in explosion-hazardous areas Ex zones 1 and 2 (gases, vapours, mists) as well as Ex zones 21 and 22 (dusts)
- Tested according to explosion group IIB
- Time-saving installation – no need to deactivate systems/areas for welding or drilling works

Part No.	540 803
Lightning impulse current (10/350 $\mu$ s) Cu ( $I_{imp}$ )	50 kA
Lightning impulse current (10/350 $\mu$ s) St/tZn ( $I_{imp}$ )	50 kA
Lightning impulse current (10/350 $\mu$ s) StSt ( $I_{imp}$ )	50 kA
Class of lightning current carrying capability acc. to DIN EN 50164-1	N
Connection	M10
Clamping range pipe $\varnothing$	89 (3")-300 mm
Material of clamping body	polyamide
Material of grip head / tensioning strap	StSt
Material of contact clip	Cu/gal Sn
Dimension of tensioning strap (l1 x w x d)	1100 x 25 x 0.3 mm
Design	UV stabilised
Standard	EN 62561-1
Weight	566 g
Customs tariff number	85389099
GTIN	4013364115477
PU	1 pc(s)



## Pipe Clamps for Hazardous Areas



### EX BRS 500 (540 805)

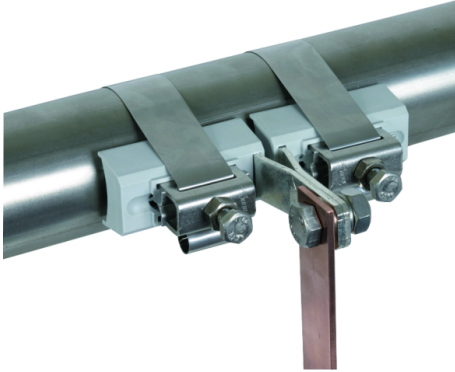
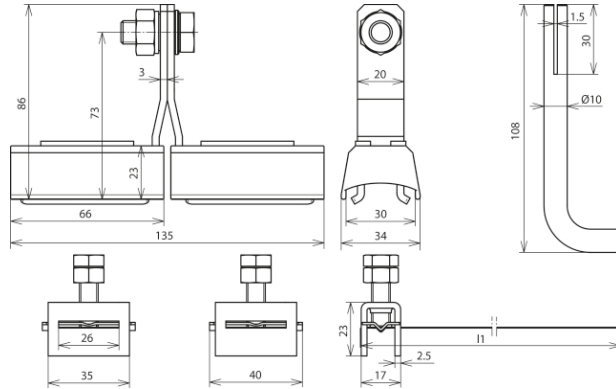

Figure without obligation



- For use in explosion-hazardous areas Ex zones 1 and 2 (gases, vapours, mists) as well as Ex zones 21 and 22 (dusts)
- Tested according to explosion group IIB
- Time-saving installation – no need to deactivate systems/areas for welding or drilling works

Part No.	540 805
Lightning impulse current (10/350 µs) St/blank ( $I_{imp}$ )	50 kA
Lightning impulse current (10/350 µs) StSt ( $I_{imp}$ )	50 kA
Class of lightning current carrying capability acc. to DIN EN 50164-1	N
Connection	M10
Clamping range pipe Ø	300-500 mm
Material of clamping body	polyamide
Material of grip head / tensioning strap	StSt
Material of contact clip	Cu/gal Sn
Dimension of tensioning strap (l1 x w x d)	1850 x 25 x 0.3 mm
Design	UV stabilised
Standard	EN 62561-1
Weight	766 g
Customs tariff number	85389099
GTIN	4013364128873
PU	1 pc(s)

## Pipe Clamps for Hazardous Areas

### EX BRS 27 (540 821)

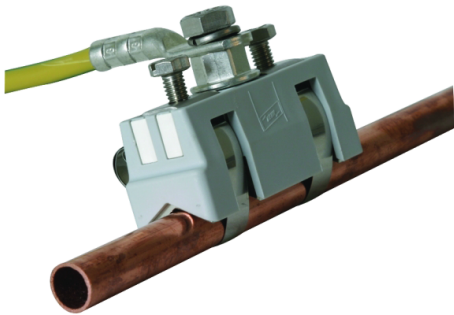
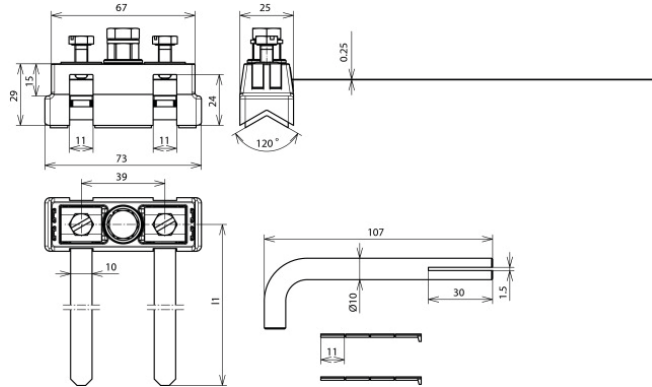

Figure without obligation



- For use in explosion-hazardous areas Ex zones 1 and 2 (gases, vapours, mists) as well as Ex zones 21 and 22 (dusts)
- Tested according to explosion group IIB
- Time-saving installation – no need to deactivate systems/areas for welding or drilling works

Part No.	540 821
Lightning impulse current (10/350 µs) Cu Ø6-12 mm ( $I_{imp}$ )	10 kA
Lightning impulse current (10/350 µs) Cu Ø12-27 mm (3/4") ( $I_{imp}$ )	20 kA
Lightning impulse current (10/350 µs) Cu Ø27 mm (3/4") ( $I_{imp}$ )	25 kA
Lightning impulse current (10/350 µs) St/Zn Ø17-27 mm (3/4") ( $I_{imp}$ )	25 kA
Lightning impulse current (10/350 µs) StSt Ø6-12 mm ( $I_{imp}$ )	10 kA
Lightning impulse current (10/350 µs) StSt Ø12-27 mm (3/4") ( $I_{imp}$ )	12 kA
Lightning impulse current (10/350 µs) StSt Ø27 mm (3/4") ( $I_{imp}$ )	25 kA
Connection	M8
Clamping range pipe Ø	6-27 mm ( $3/4$ "")
Material of clamping body	polyamide
Material of grip head / tensioning strap	StSt
Material of contact clip	brass/gal Sn
Dimension of tensioning strap (l1 x w x d)	190 x 10 x 0.25 mm
Design	UV stabilised
Standard	EN 62561-1
Weight	249 g
Customs tariff number	85389099
GTIN	4013364123724
PU	1 pc(s)

Concrete Base

**BES 17KG KT16 D337 SET (102 010)**



Figure without obligation

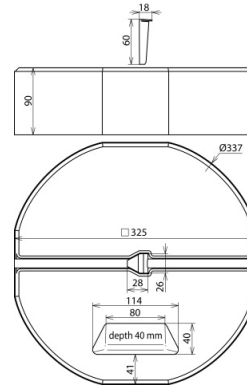

Concrete base for air-termination rods protecting small-sized roof superstructures on flat roofs and for installing spacers, e.g. for isolated ring conductors or for self-supporting air-termination rods in the tripod (only with a weight of 17 kg). Stackable type, for air-termination rods Rd 16 mm, chamered, tapered, or DEHNiso spacers Rd 16 mm.

Part No.	102 010
Component protection	German utility model No. 94 07 712.6
Type	stackable
Support	wedge Ø16 mm
Diameter Ø	337 mm
Material	concrete (C45/55)
Material of wedge	StSt
Weight	17,62 kg
Customs tariff number	85389099
GTIN	4013364057814
PU	54 pc(s)

**ULP KS D370 SW (102 050)**



Figure without obligation

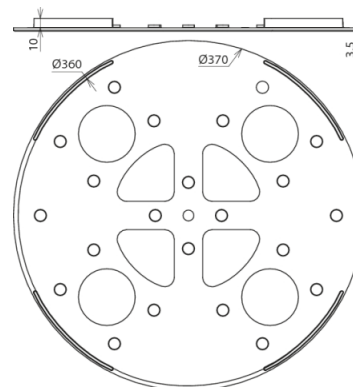

Support plate to protect the roof sheeting under the concrete base, large design for the 17 kg base.

Part No.	102 050
Diameter Ø outside	370 mm
Diameter Ø inside	360 mm
Material	EVA
Colour	black •
Weight	217 g
Customs tariff number	39269097
GTIN	4013364045996
PU	1 pc(s)

Earthing Busbar

ES 2X2AP 10 V2A (472 109)



Figure without obligation

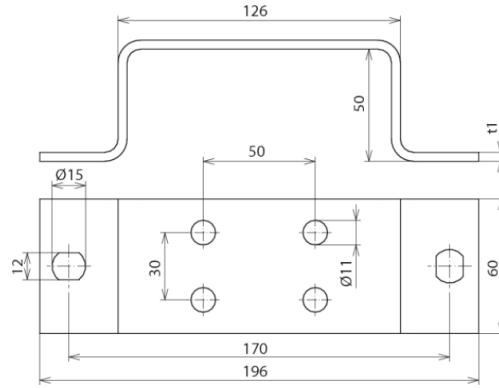

Part No.	472 109
Material	StSt
Cross section	300 mm <sup>2</sup>
Connection bores Ø	11 mm
Dimension (l x w x d1)	196 x 60 x 5 mm
Fixing	[2x] 12 x 15 mm
Standard	EN 62561-1
Weight	604 g
Customs tariff number	85389099
GTIN	4013364074477
PU	1 pc(s)

[www.dehn-international.com/partners](http://www.dehn-international.com/partners)



**Surge Protection  
Lightning Protection  
Safety Equipment  
DEHN protects.**

DEHN + SÖHNE  
GmbH + Co.KG.

Hans-Dehn-Str. 1  
Postfach 1640  
92306 Neumarkt  
Germany

Tel. +49 9181 906-0  
Fax +49 9181 906-1100  
[info@dehn.de](mailto:info@dehn.de)  
[www.dehn-international.com](http://www.dehn-international.com)



[www.dehn-international.com/partners](http://www.dehn-international.com/partners)

Type designations of products mentioned in the white paper being at the same time registered trademarks are not especially marked. So if there is no marking of <sup>TM</sup> or © this does not mean that the type designation is a free trade name. Neither it can be seen whether patents or utility models and other intellectual and industrial property rights are available. We reserve the right to introduce changes in performance, configuration and technology, dimensions, weights and materials in the course of technical progress. The figures are shown without obligation. Misprints, errors and modifications excepted. Reproduction in any form whatsoever is forbidden without our authorisation.

actiVsense, BLITZDUCTOR, BLITZPLANER, DEHN, DEHN Logo, DEHN schützt, DEHNbloc, DEHNfix, DEHNgrip, DEHNguard, DEHNport, DEHNQUICK, DEHNrapid, DEHNshield, DEHNSnap, DEHNventil, HVI, LifeCheck, Red/Line are protected by German Trade Mark, by Community Trade Mark (EU) and/or in other countries.